

# Assembly & Installation Instructions

**CAUTION:** Read instructions carefully and turn electricity off at main circuit breaker panel before beginning installation.

## 4003

\*\*\*\*\*

**WARNING** - If any Special Control Devices are used with this Fixture, Follow the Instructions Carefully to assure full compliance with N.E.C. requirements. If there are any questions, contact a Qualified Electrical Contractor.

**WARNING** - This product contains chemicals known to the State of California to cause cancer, birth defects and /or other reproductive harm. Thoroughly wash hands after installing, handling, cleaning, or otherwise touching this product.

**CAUTION** - All glass is fragile, use care when handling Glass component(s) and or Lamp(s).

\*\*\*\*\*

### ASSEMBLY STEPS:

1. #29 (Ø.136) (3.5mm) C
2. V,W,X C
3. D,E A
4. F D
5. B,A C
6. M N
7. Y,Z M
8. O,P,Q M
9. K L
10. J I

11. Thread Fixture Wires Up Through Chain, (I), (G), & (A). Trim Wires To Extend 6-Inches (15.5cm) Above (A). Strip Wire Insulation 1/2-Inch (1.5cm). Connect Fixture Wires To Supply Wires As Shown On Wiring Diagram.
12. G,H D

ADJUST HEIGHT WITH D  
 F A TO LOCK

13. S,T R
14. U R

NOTE: THIS FIXTURE INCLUDES AN ADDITIONAL SUPPORT CABLE. ATTACH SUPPORT CABLE SECURELY TO THE OUTLET BOX. DO NOT USE THE SUPPORT CABLE TO MAKE ANY ELECTRICAL CONNECTIONS.

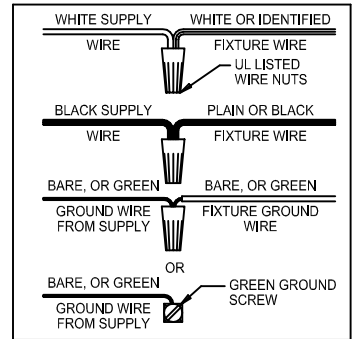

B, C & U  
 (NOT FURNISHED)  
 (NO INCLUIDA)  
 (NON FOURNIE)

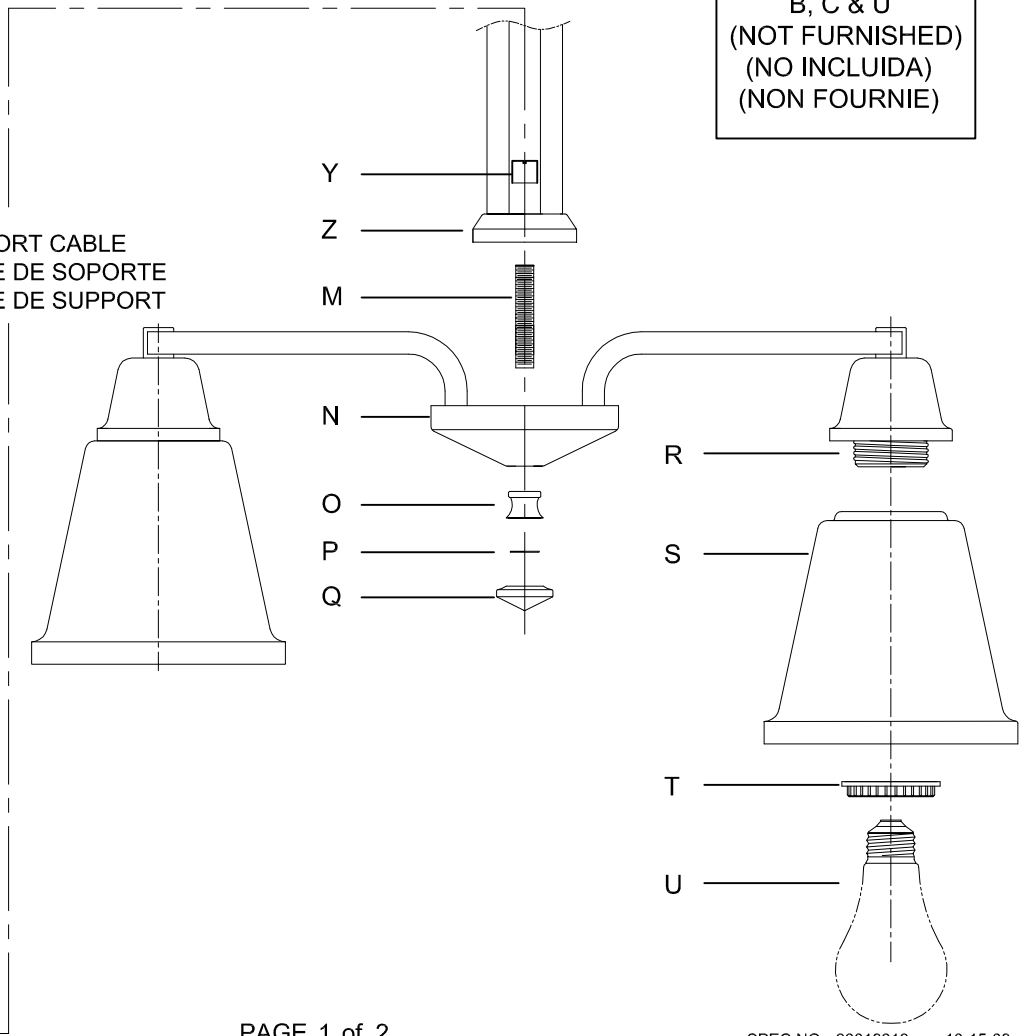
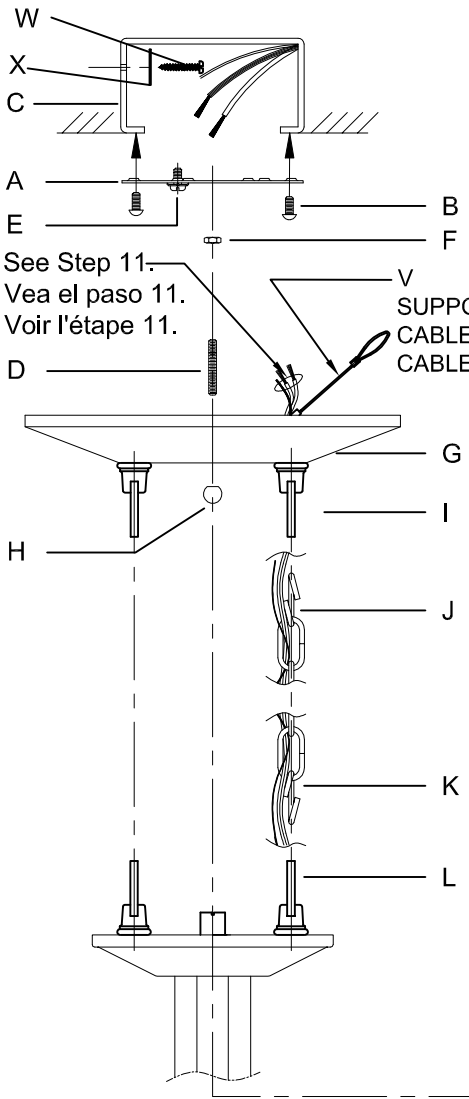

SUPPORT CABLE  
 CABLE DE SOPORTE  
 CABLE DE SUPPORT

See Step 11.  
 Vea el paso 11.  
 Voir l'étape 11.

# Instrucciones de ensamblaje e instalación











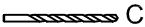

Precaución: Lea cuidadosamente las instrucciones y desconecte la electricidad del cortacircuitos principal antes de iniciar la instalación.

**ADVERTENCIA** - Si usa algún dispositivo especial de control con este aparato de luz, siga las instrucciones cuidadosamente para asegurar la completa conformidad con los requisitos N.E.C. Si existe alguna duda, contacte un electricista calificado.

**ADVERTENCIA:** Este producto contiene sustancias químicas que según el Estado de California causa cáncer, defectos de nacimiento y (o) daño al sistema reproductor. Lavarse bien las manos después de instalar, manipular, limpiar o tocar de manera alguna este producto.

**PRECAUCION** - El vidrio es frágil; tenga cuidado al manipular el (los) elemento(s) de vidrio y/o la(s) bombilla(s).



## PASOS PARA ENSAMBLAR:

1. #29 (Ø.136) (3.5mm)  C
2. V,W,X  C
3. D,E  A
4. F  D
5. B,A  C
6. M  N
7. Y,Z  M
8. O,P,Q  M
9. K  L 
10. J  I 

11. Pase los alambres del aparato de luz hacia arriba por la cadena, (I), (G), y (A). Recorte los alambres de modo que sobresalgan 6 pulgadas (15.5 cm) por encima de (A). Pele los cabos de los alambres aislados hasta ½ pulgada (1.5 cm). Conecte los alambres del aparato de luz a los alambres del suministro como se muestra en el diagrama de conexiones.

12. G,H  D

AJUSTAR LA ALTURA CON D  
F  A APRETAR

13. S,T  R
14. U  R

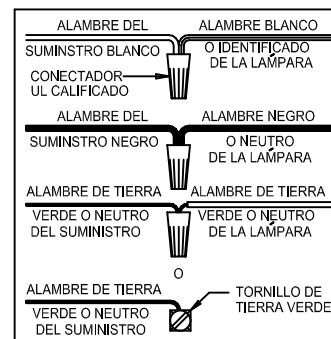

NOTA: ESTE ACCESORIO INCLUYE UN CABLE ADICIONAL DE LA AYUDA. UNA EL CABLE DE LA AYUDA CON SEGURIDAD A LA CAJA DEL ENCHUFE. NO UTILICE EL CABLE DE LA AYUDA PARA HACER NINGUNA CONEXIONES ELÉCTRICA.

# Instructions d'Assemblage et Installation









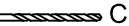

Mise en garde: Lire les instructions avec soin et couper le courant au disjoncteur central avant de commencer l'installation.



**AVERTISSEMENT** - S'il y a d'autres mécanismes régulateurs qui s'emploient avec ce dispositif, suivre soigneusement les instructions pour satisfaire aux exigences NEC. Si vous avez des questions, consulter un électricien qualifié.

**AVERTISSEMENT:** Ce produit contient des composants chimiques qui selon L'état de Californie provoquent un cancer, des infirmités de naissance et (ou) du mal au système reproductif. Il faut laver les mains soigneusement après avoir installé, manipulé, nettoyé, ou autrement touché ce produit.

**MISE EN GARDE** - Le verre est toujours fragile; maniez le(s) composant(s) et/ou l' (les) ampoule(s) avec prudence.

## MODE D'ASSEMBLAGE:



1. #29 (Ø.136) (3.5mm)  C
2. V,W,X  C
3. D,E  A
4. F  D
5. B,A  C
6. M  N
7. Y,Z  M
8. O,P,Q  M
9. K  L 

10. J  I 

11. Faites passer les fils du dispositif d'éclairage vers le haut par la chaîne, (I), (G), et (A). Ajustez la longueur des fils en sorte qu'ils dépassent avec 6 pouces (15.5 cm) sur (A). Dénudez les bouts des fils isolés sur ½ pouce (1.5 cm). Reliez les fils du dispositif d'éclairage aux fils de l'alimentation selon le diagramme de câblage.

12. G,H  D

RÉGLEZ LA HAUTEUR AVEC D  
F  A À VERROUILLER

13. S,T  R
14. U  R

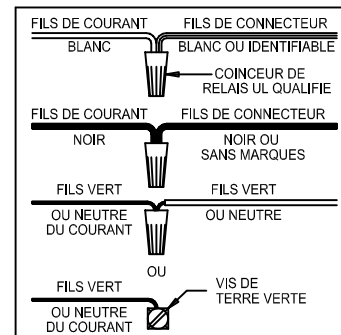

NOTE : CE MONTAGE INCLUT UN CÂBLE ADDITIONNEL DE SOUTIEN. ATTACHEZ LE CÂBLE DE SOUTIEN SOLIDEMENT DANS LA BOÎTE DE SORTIE. N'EMPLOYEZ PAS LE CÂBLE DE SOUTIEN POUR N'ÉTABLIR AUCUN RAPPORT ÉLECTRIQUE.