

KEATON

Shower Trim

3-2494BP

Also 3-395

Features

- Solid brass construction
- Face plate with ADA compliant contemporary lever handle
- 1.8 gallons (6.7 liters) per minute maximum flow rate showerhead
- ADA compliant contemporary lever handle assembly for control valve
- Intended for use with Newport Brass rough valve(s) as specified (Required Accessory)

Codes / Standards Compliance

Meets or exceeds the following at date of manufacture:

- ASME A112.18.1/CSA B125.1
- IAPMO/cUPC
- IPC
- ADA
- ICC/ANSI A117.1
- ASSE 1016
- Energy Policy Act of 1992
- EPA Watersense
- All applicable US Federal and State material regulations

Colors / Finishes

- 10B: Oil Rubbed Bronze
- 15: Polished Nickel
- 15S: Satin Nickel - PVD
- 26: Polished Chrome
- Other: Refer to the Newport Brass catalog for additional color/finish options.



3-2494BP



3-395

Specified Model

Model	Description	Colors Finishes				
3-2494BP	Shower Trim	<input type="checkbox"/> 10B	<input type="checkbox"/> 15	<input type="checkbox"/> 15S	<input type="checkbox"/> 26	<input type="checkbox"/> Other
3-395	Shower System Control Valve Trim (Escutcheon/Handle)	<input type="checkbox"/> 10B	<input type="checkbox"/> 15	<input type="checkbox"/> 15S	<input type="checkbox"/> 26	<input type="checkbox"/> Other

Required Accessory: Trim(s), above, and Rough Valve(s), below, must be specified.

Application	Shower (or Tub) Valve (Choose One)		Control Valve
Description	Balance Pressure (BP)	Balance Pressure (BP)	Diverter (3/4 Port)
Inlet/Outlet Size	1/2"	1/2"	1/2"
Part Number	<input type="checkbox"/> 1-594	<input type="checkbox"/> 1-684	<input type="checkbox"/> 1-617
Image			

Product Specification: Add size designator and "Color / Finish" suffix to Model number, below.

The single-control Shower Trim shall be made of solid brass construction. Shower Trim shall include showerhead with arm and flange and faceplate with ADA compliant handle. Showerhead shall have a maximum flow rate of 1.8 gallons (6.7 liters) per minute. Shower System Control Valve Trim(s) (Escutcheon/Handle) shall be ADA compliant when used with specified Shower System Control Valve. Shower Trim shall be Newport Brass Model 3-2494BP/____ and single-control Shower rough valve shall be Newport Brass Model 1-____. [Optional Shower System Control Valve Trim (Escutcheon/Handle) shall be 3-395/____ and Shower System Control Valve shall be 1-617].

3-2494BP

PRODUCT DIMENSIONS *(Units are in inches)*

NOTES:

- 1 CUT STEM AS SHOWN.
- 2 CUT ALL-THREAD 3/4" SHORTER THAN STEM
- 3 PN: 1-594 TO BE SOLD SEPARATELY.

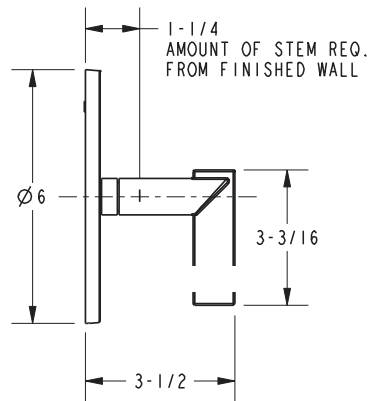
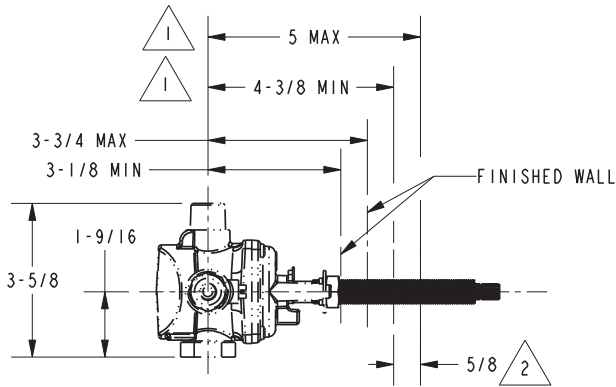
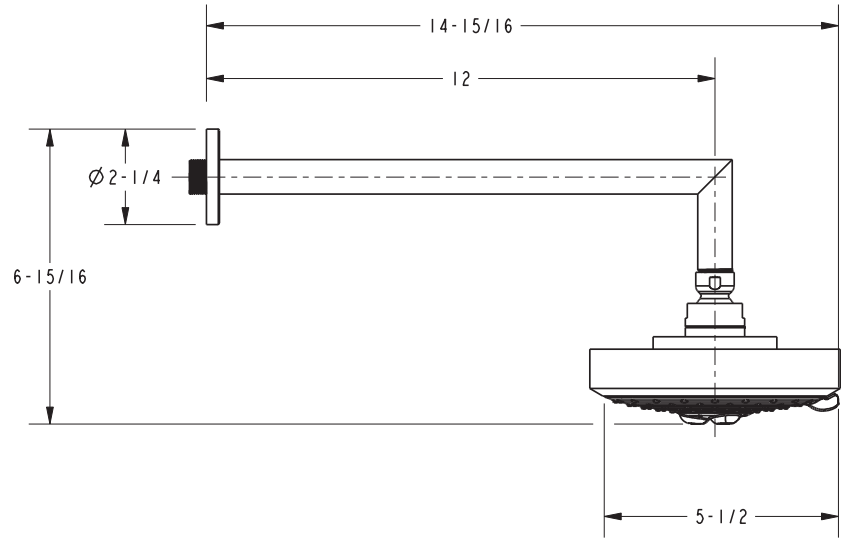
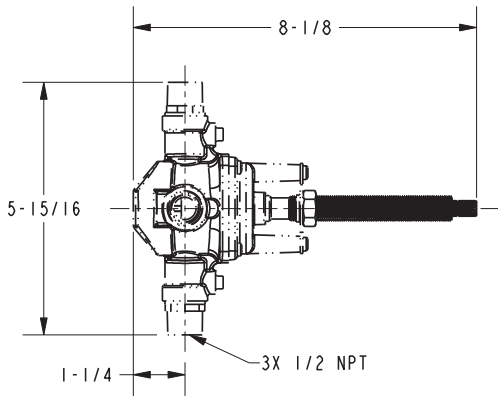

Keaton Shower Trim 3-2494BP