

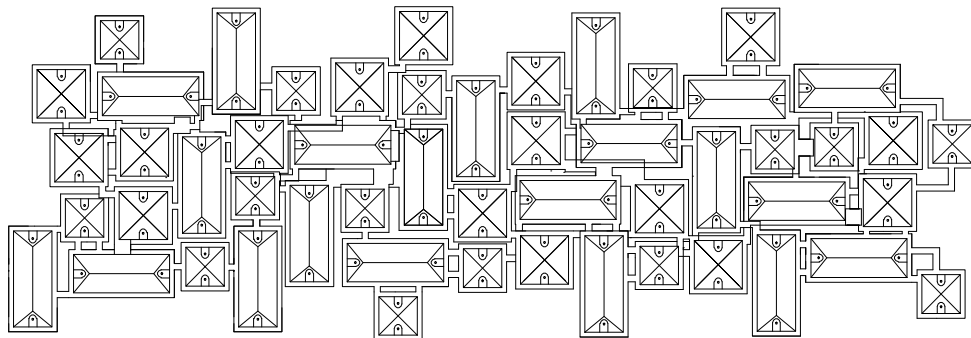

**PRODUCT NAME: Paradigm**  
**ITEM NUMBER: 39818**

**Please consult your electrician for hanging fixture and wiring.**



**Caution: Xenon bulbs get very hot and may burn you. Always make sure bulbs are off for a minimum of 10 minutes before handling. Fixture may be dimmed using an electronic low voltage dimmer.**

**6 x 40W G9 Bulbs**

**MADE IN CHINA**  
**Page 1 of (2)**

**IMPORTANT: Turn OFF the power at the main fuse or circuit breaker box before starting installation**

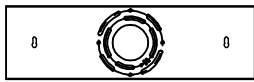

**A**  
Mounting Hardware



**B**  
Back Plate



**C**  
Bulb

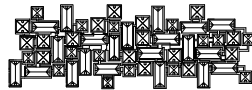

**D**  
Crystal lamp holder



**E**  
Tube



**F**  
Back Plate Screws

**Locate all hardware & components before discarding packaging**

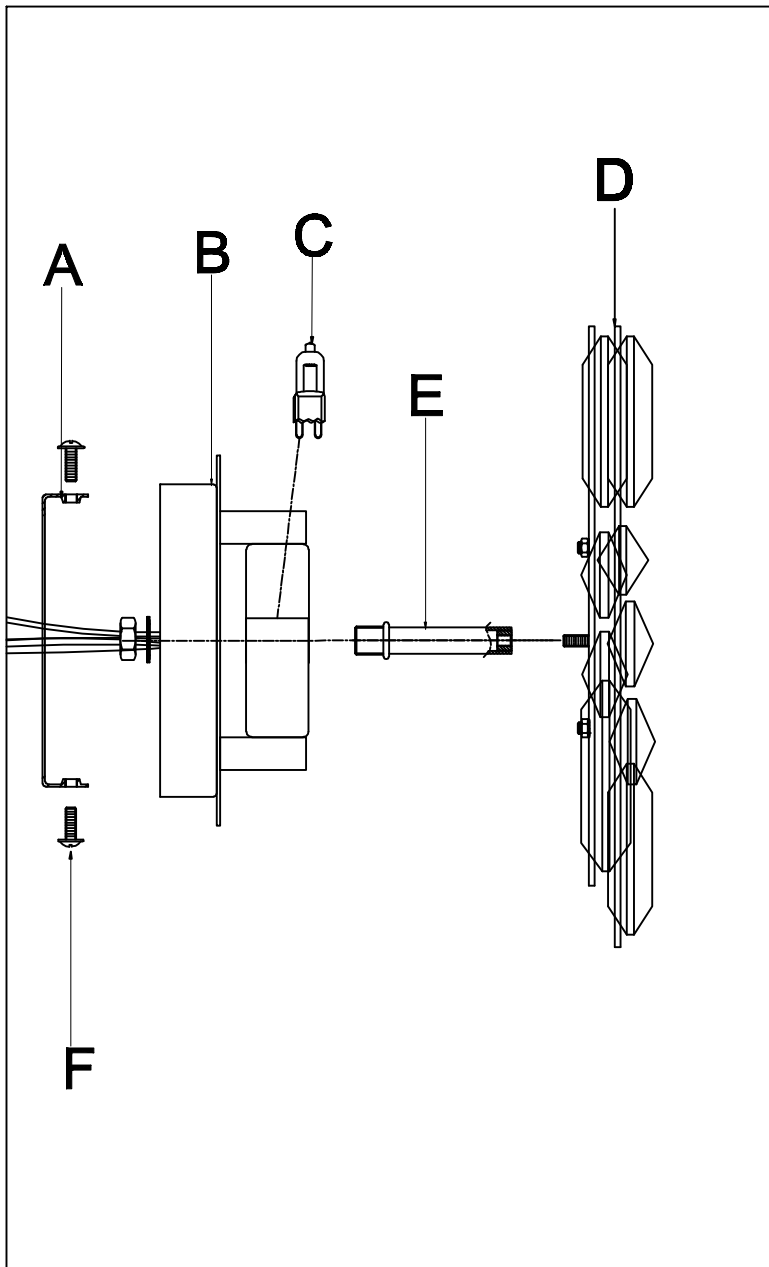

1.)

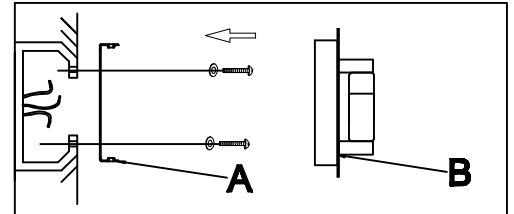

**Step.1: Remove mounting bracket (A) from back plate (B) and install to electrical box.**

2.)

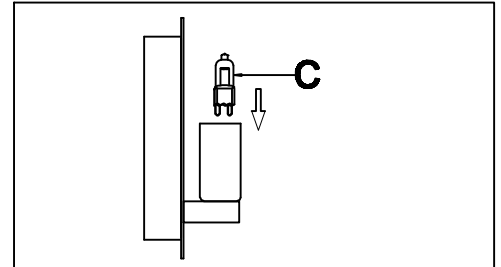

**Step.2: Fit the bulbs (C) into each socket . Do not use bare hands to install.**

3.)

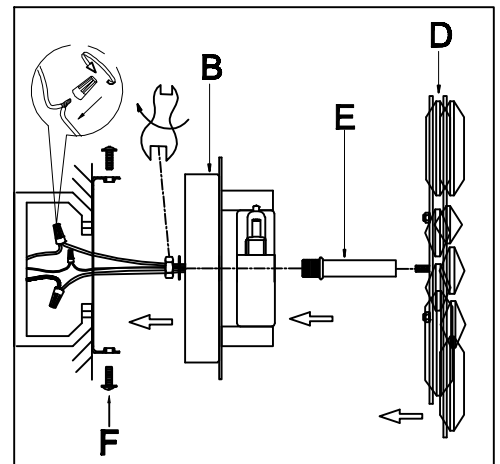

**Step.3: Screw the tube(E) on the Crystal lamp frame(D),then lock (E) on the backbox(B) with nut. Connect the wires with the wiring cap  
Fix the Backbox(B) on the backboard(A) with screw.**

**Step.4: Attach fixture to mounting bracket and tighten screws on the side to secure.**

### **Cleaning & Care:**

**Clean with soft cloth and a mild detergent.  
Do not use abrasive cleaner.**