

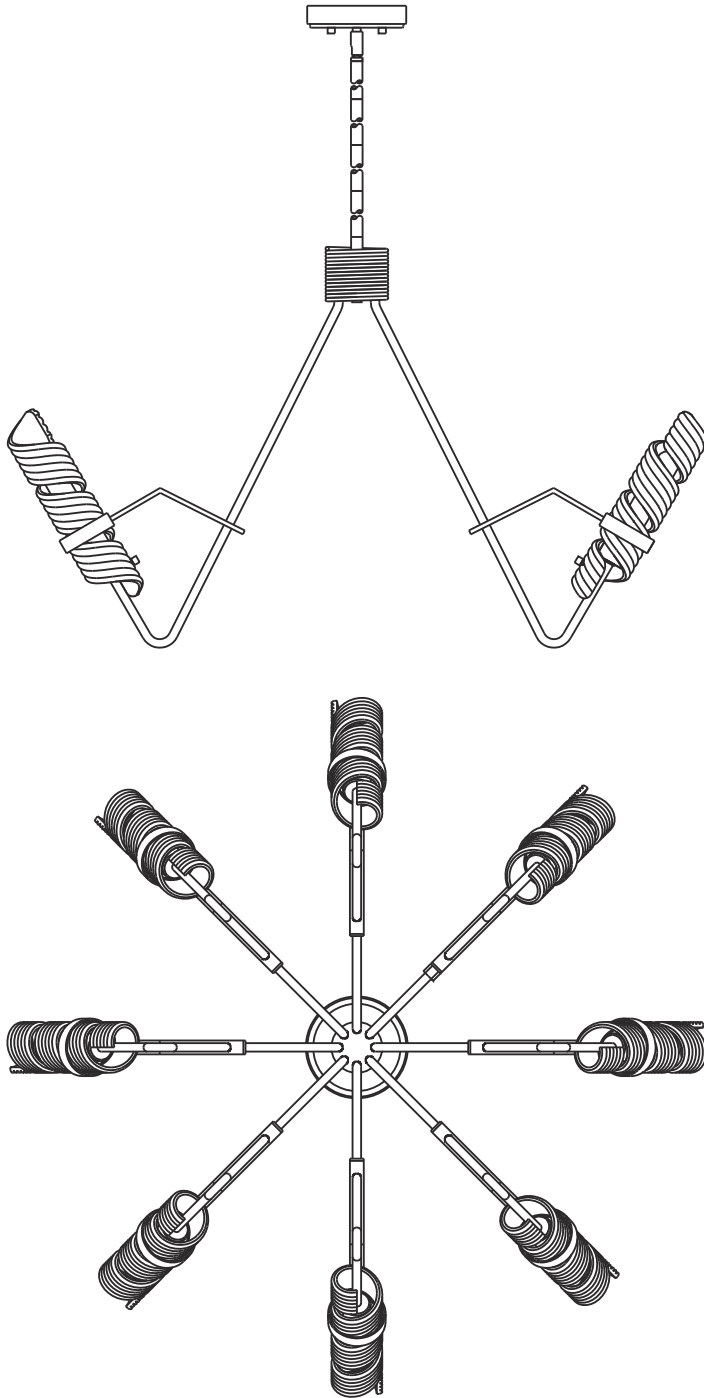

PRODUCT NAME: Milano 8 Light Chandelier  
ITEM NUMBER: 39556CLPN

Please consult your electrician for hanging fixture and wiring.



MB T10 8x60W

**IMPORTANT:** Turn off the power at the main fuse or circuit breaker box before starting installation.

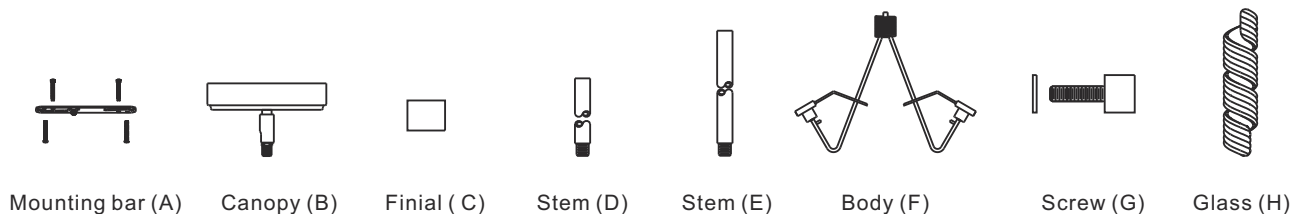

Locate all hardware & components before discarding packaging

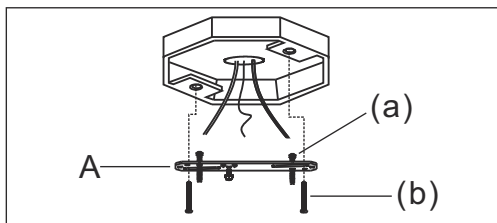
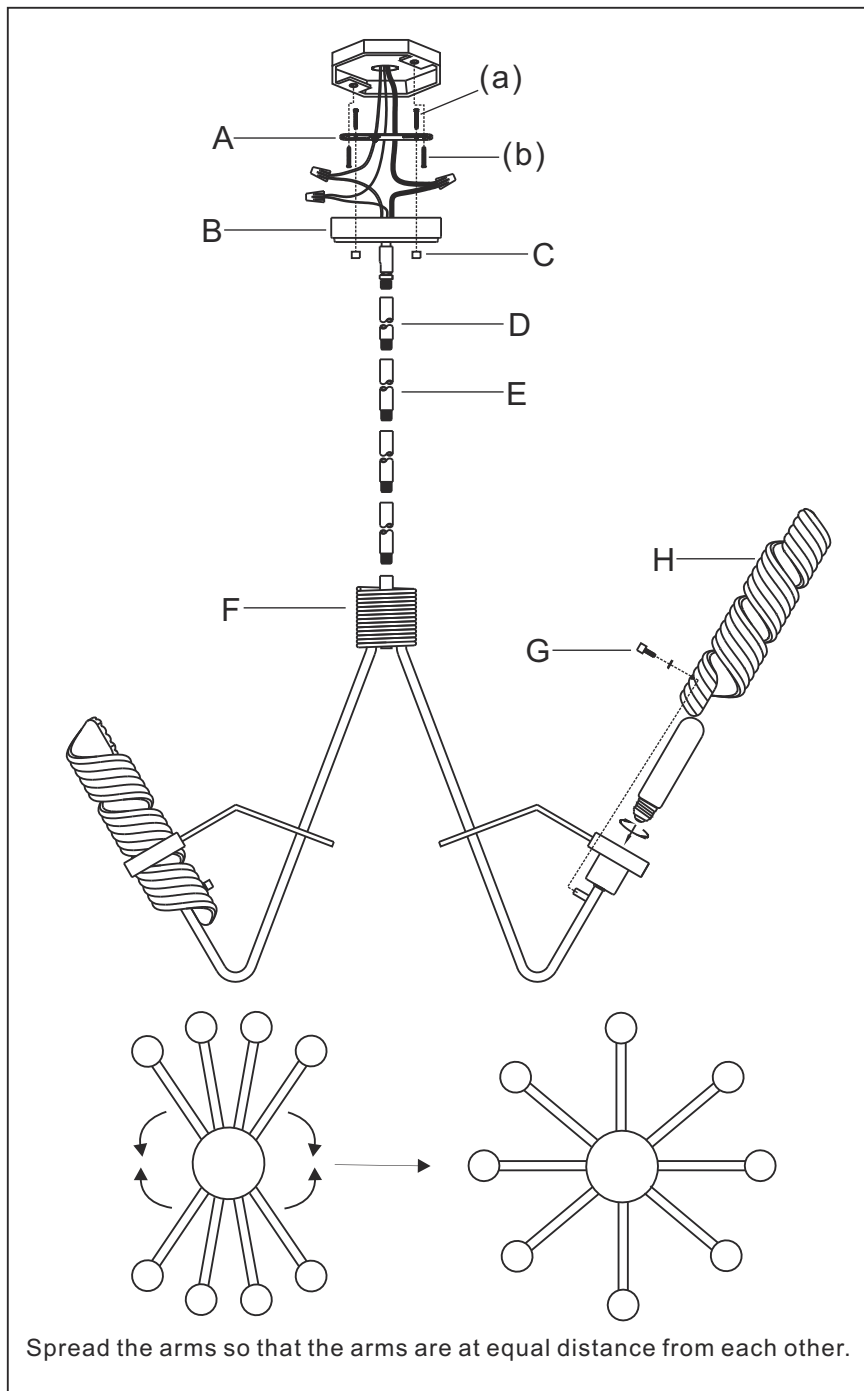

1). Thread the mounting screws (a) into the matching holes in the mounting bar (A). Attach mounting bar (A) to junction box using screws (b).

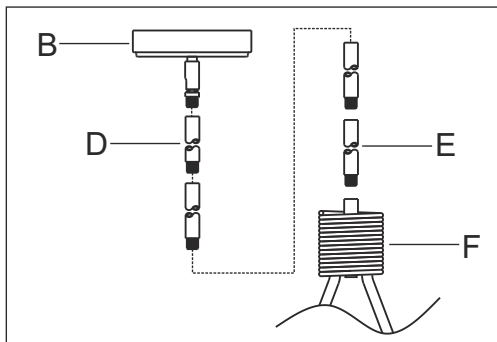

2). Slip first stem section (E) along wire and thread into top of main fixture body (F). Repeat for assembly stem (D) and canopy (B).

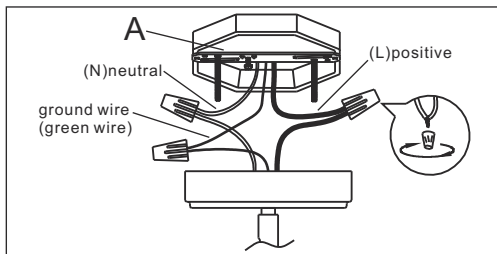

3). Wire fixture to wires in junction box. Copper wire is for Ground.

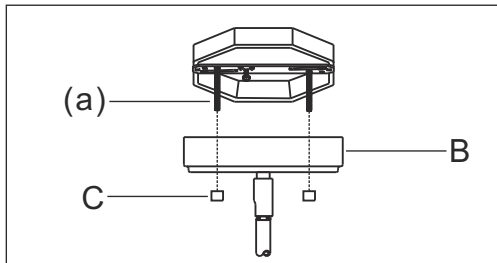

4). Raise canopy (B) over screws (a) and secure with finials (C). Install light bulb. Place glass (H) over the socket, and then secure glass with screw (G).

**Cleaning & Care:**

Clean with soft cloth and a mild detergent.  
Do not use abrasive cleaner.