

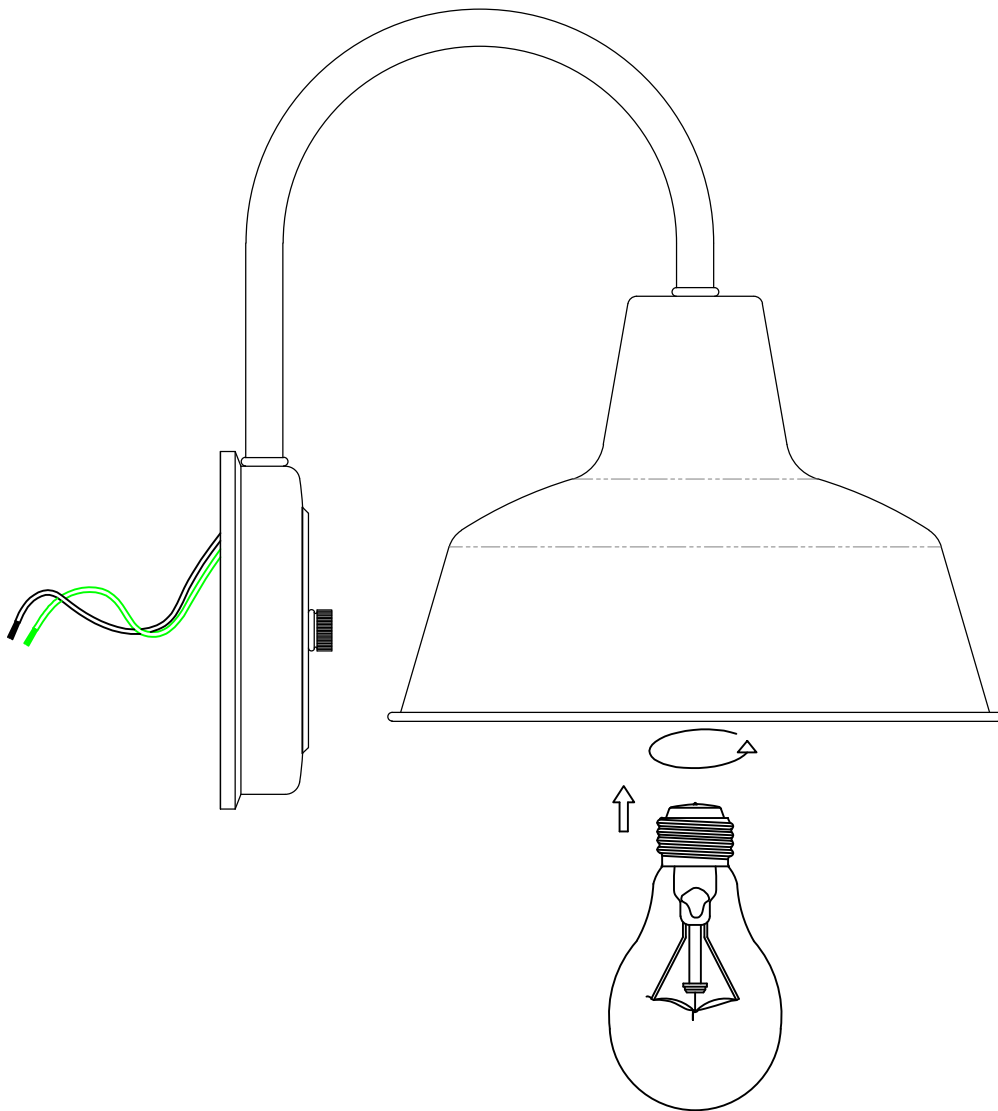

PRODUCT NAME: Pier M 1-Light Wall Sconce
ITEM NUMBER: 35015

Please consult your electrician for hanging fixture and wiring.



WARNING: To prevent water intrusion, caulk around back-plate where fixture meets the wall using outdoor silicone sealant. Leave a small gap at the bottom to allow moisture to exit.

Bulb (not included): : 1 x 60W Candelabra Bulb

IMPORTANT: Turn off the power at the main fuse or circuit breaker box before starting installation

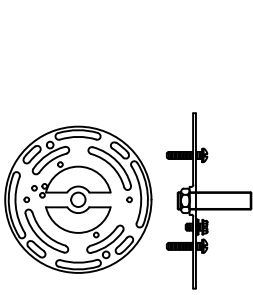

Bracket (A)

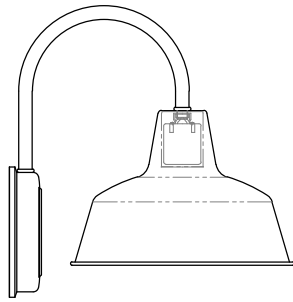

Integral lamp holder (B)



decorative nut (C)

Locate all hardware & components before discarding packaging

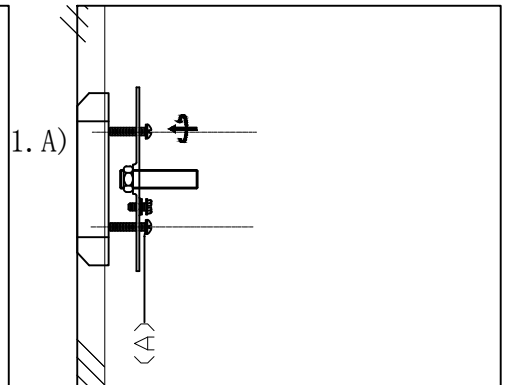
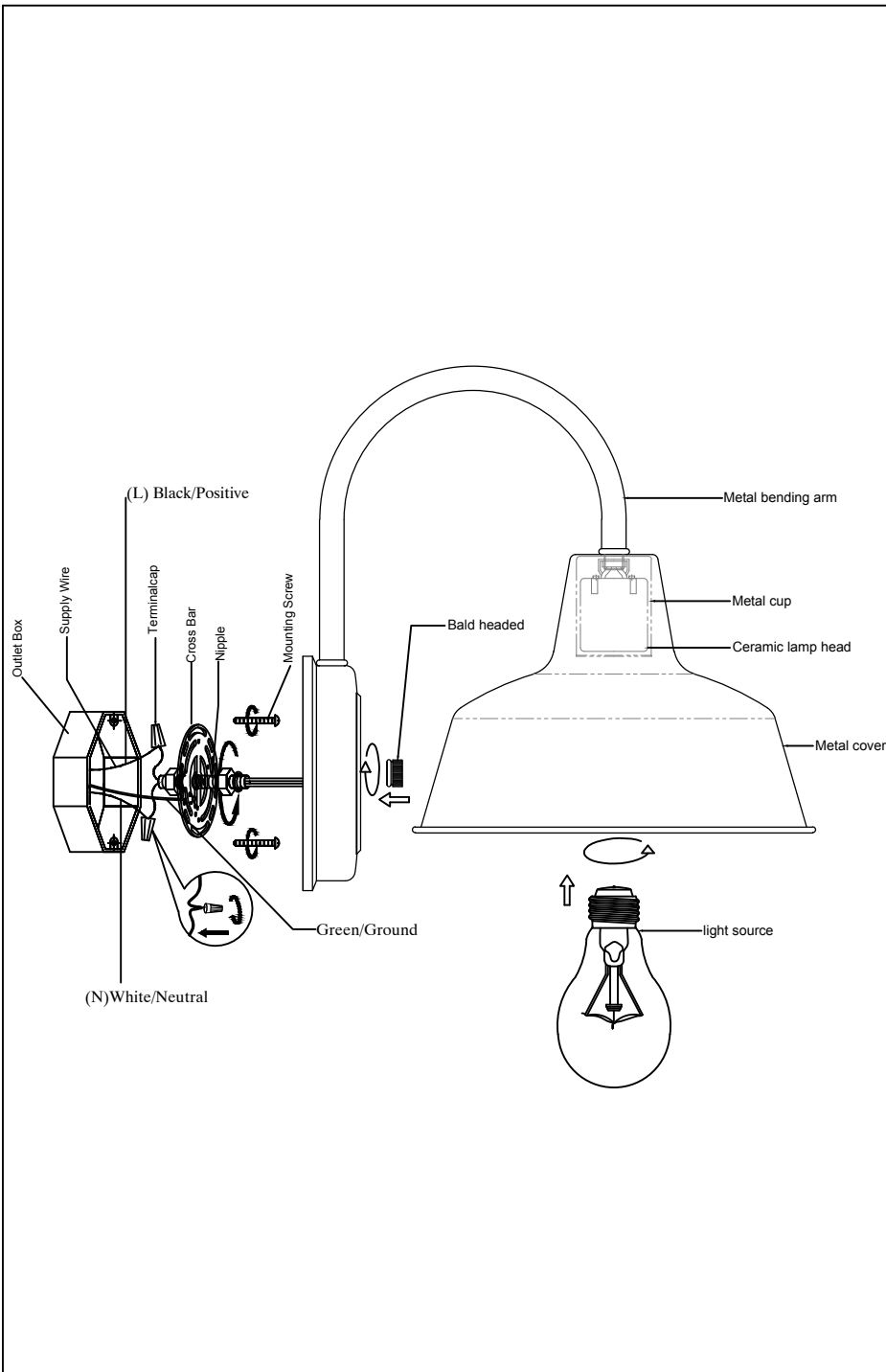

Step.1 Remove mounting bracket from fixture and install to electrical box.

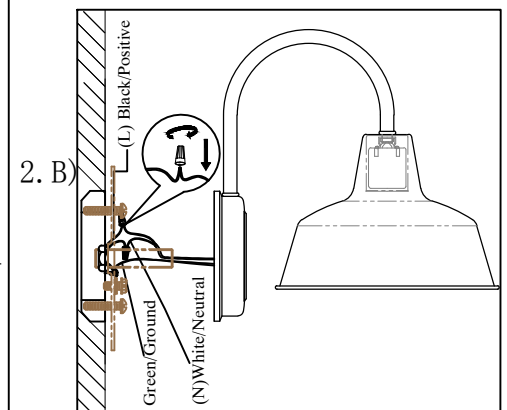

Step.2 Wire fixture to wires in outlet box. Black wire is positive, white is neutral, bare wire is ground.

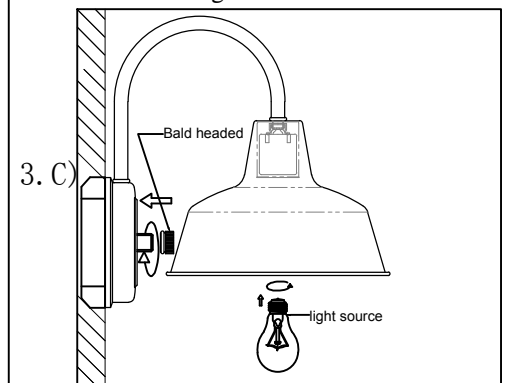

Step.3 Put the connected line into the electric box and fasten the light body with the decorative nut.

Cleaning & Care:
Clean with soft cloth and a mild detergent.
Do not use abrasive cleaner.