

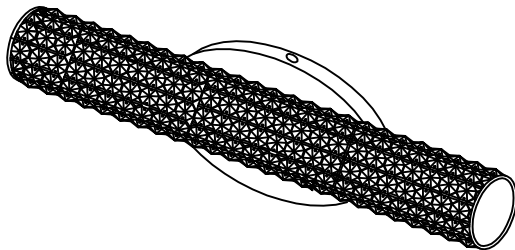

PRODUCT NAME: Meteor
ITEM NUMBER: 32502BCPC

Please consult your electrician for hanging fixture and wiring.



The fixture is designed to dim with a standard Triac forward phase dimmer. Dimming levels will vary by dimmer. The above belongs in box with recommended drivers.

Below is a list of recommended dimmers:

Lutron MACL-153M

Lutron DVL-153P

Lutron SCL-153P

Leviton IPL06-10Z

Leviton 6674-POW

Due to inrush current wattage should not exceed 150 watts of product a 600 watt dimmer.

WARNING: WIRES NEED TO BE CONNECTED TO DRIVER FOUND IN CANOPY AND SHOULD NOT CONECT DIRECTLY TO POWER SOURCE OR A SHORT MIGHT OCCUR.

8W LED

IMPORTANT: Turn off the power at the main fuse or circuit breaker box before starting installation



(A)
Mounting Bracket

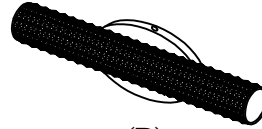

(B)
Body

Locate all hardware & components before discarding packaging

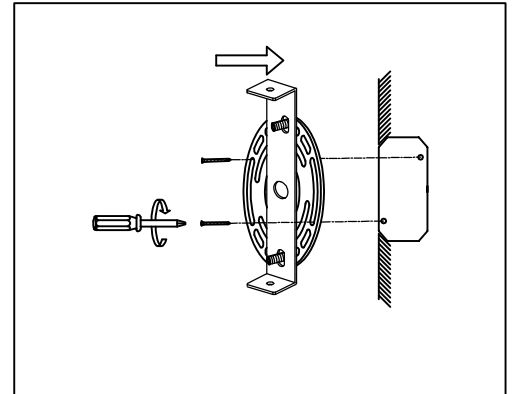
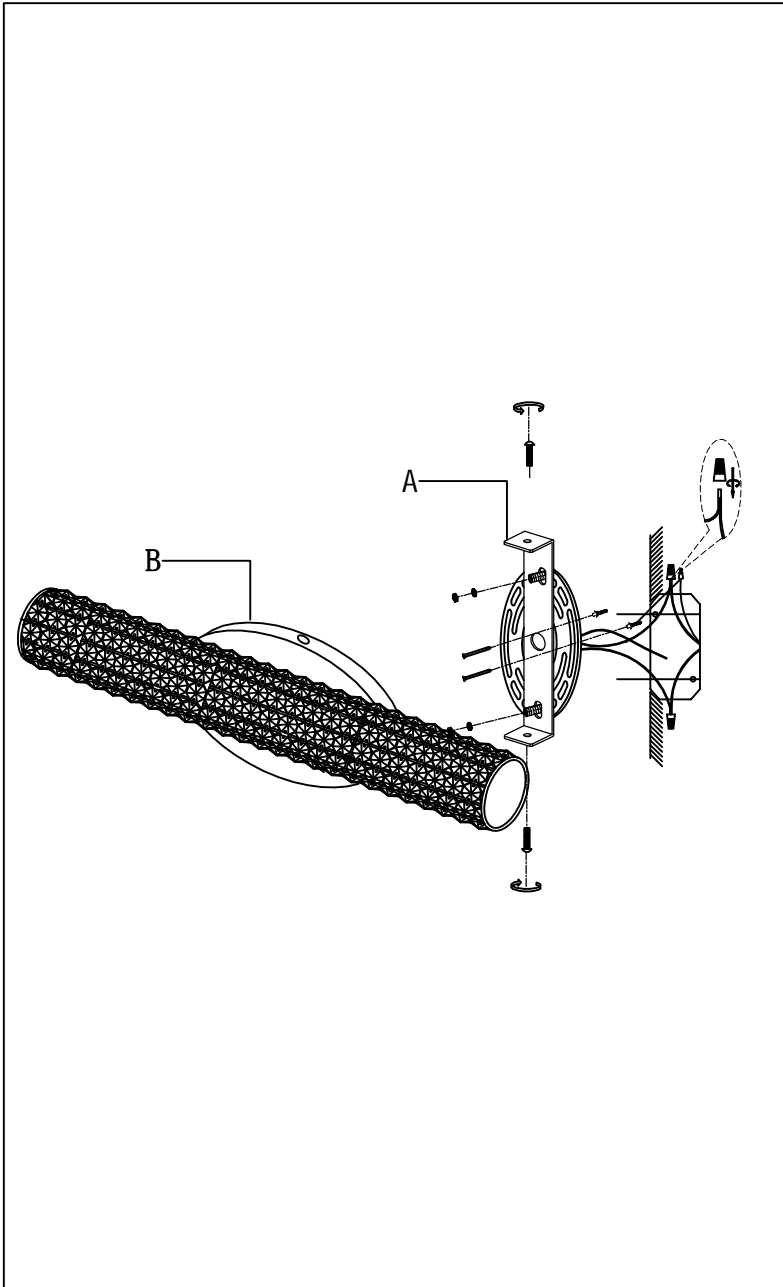

1.)

Step.1: Remove mounting bracket (A) from fixture and install to electrical box.

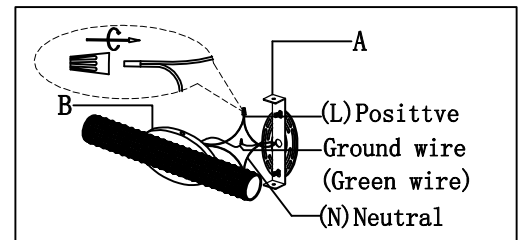

2.)

Step.2: Wire fixture to wires in outlet box. Install green wire is for Ground.

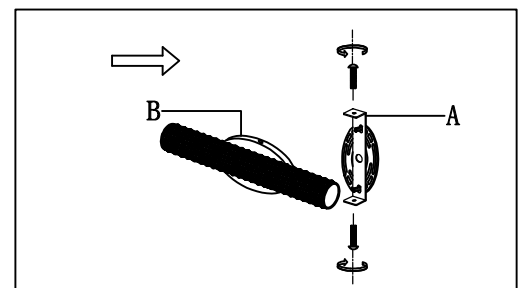

3.)

Step.3: Install Body(B) to Canopy(A) and tighten screws at the ends of the canopy to secure.

Cleaning & Care:

Clean with soft cloth and a mild detergent.
Do not use abrasive cleaner.