

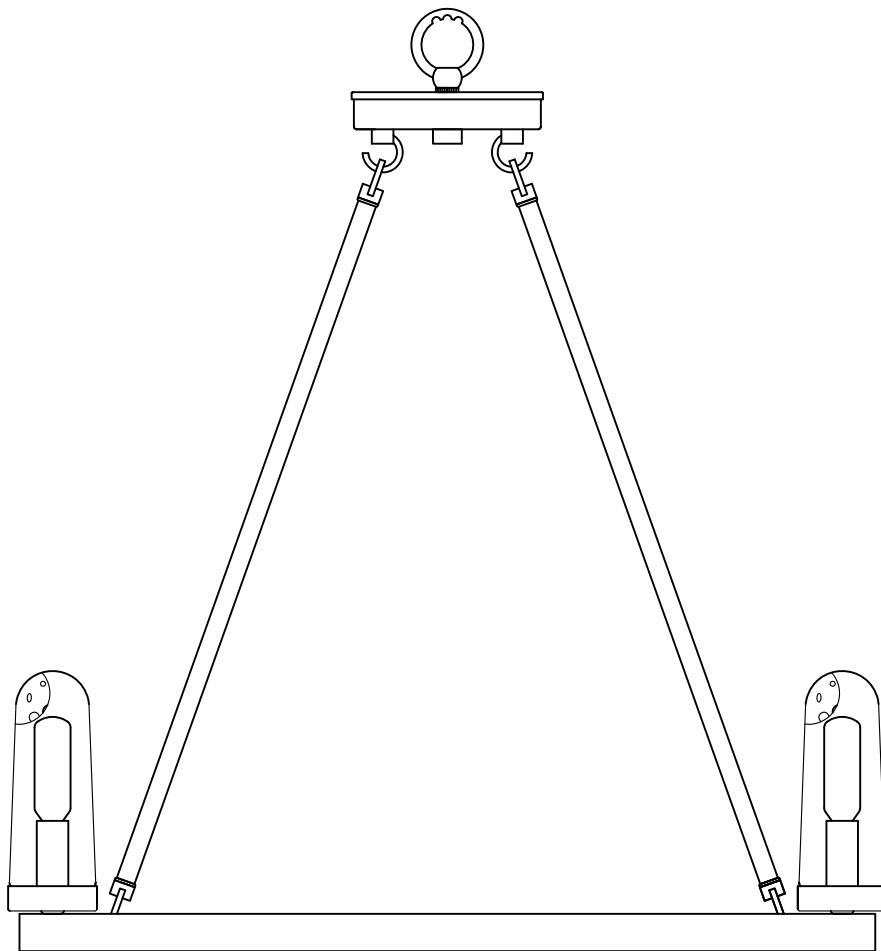

PRODUCT NAME: Lido 6-Light Outdoor Pendant
ITEM NUMBER: 30016

Please consult a qualified electrician for hanging fixture and wiring.



Bulb (included): 6*40W*T6 E12 Bulbs

IMPORTANT: Turn off the power at the main fuse or circuit breaker box before starting installation

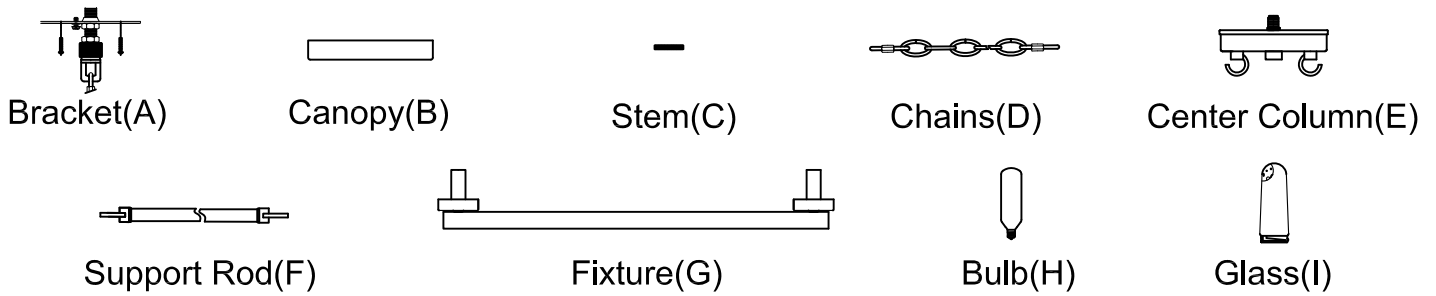

Locate all hardware & components before discarding packaging

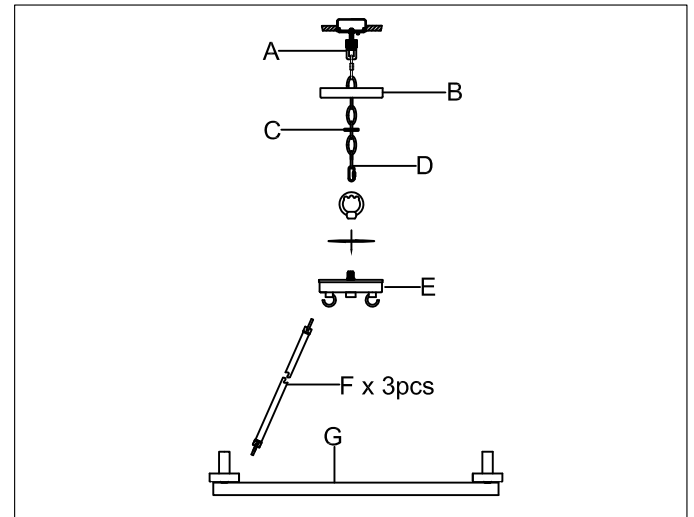
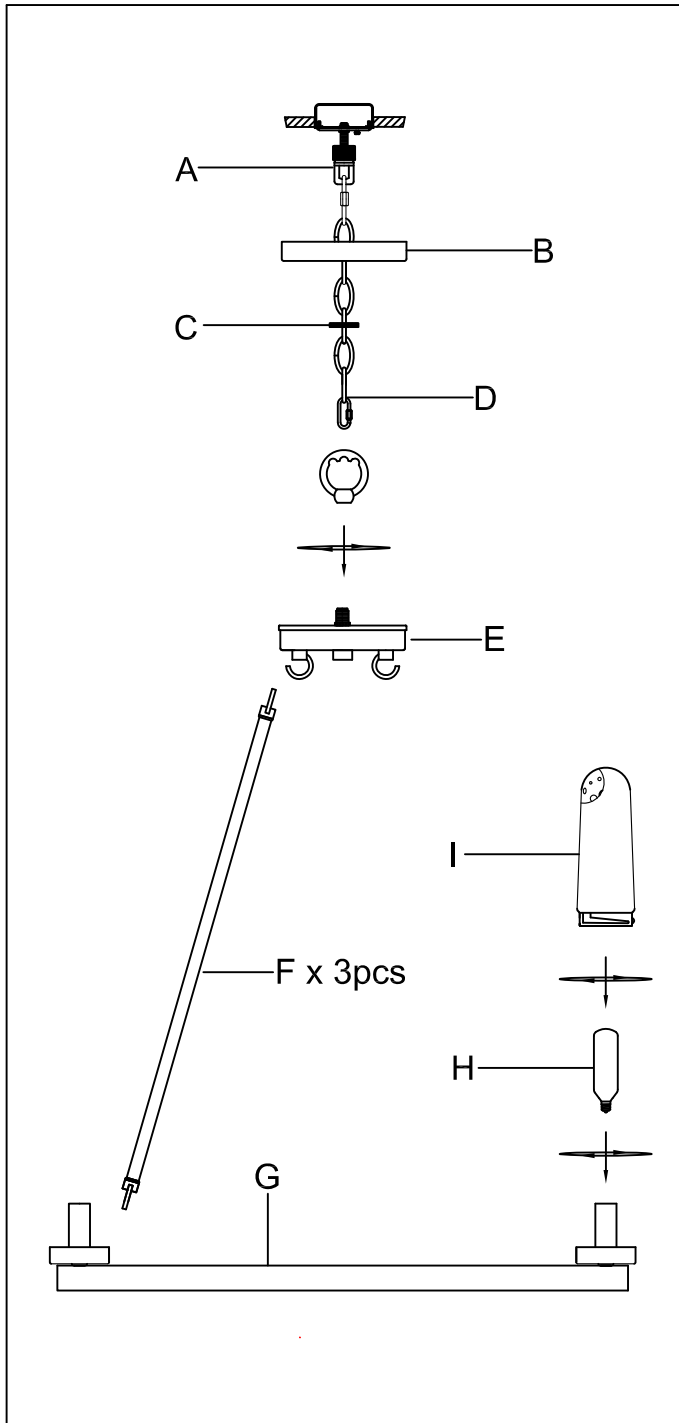

- Step1. Remove mounting bracket from fixture and install to electrical box.
2. Run wire through top loop and install.
3. Hook the top of each Support Rod (F) into the loops on the Center Column (E) and attach the Rod bottom to the Fixture Body (G) hooks
4. Attach appropriate amount of chain to loop to achieve desired mounting height. Thread wire through every 3rd loop of chain.
5. Attach fixture to canopy using chain connectors at the beginning and end of the chain. Connect to top loop and canopy.
6. Wire fixture to wires in outlet box. Copper wire is for Ground.
7. Press canopy up to ceiling and secure with ball nuts.

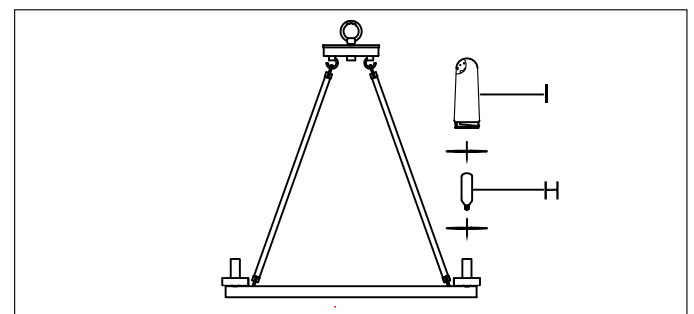

- Step8. Install 6 max 40W E12 bulbs (H) into socket.
9. Thread glass (I) onto cup.

Cleaning & Care:
Clean with soft cloth and a mild detergent.
Do not use abrasive cleaner