

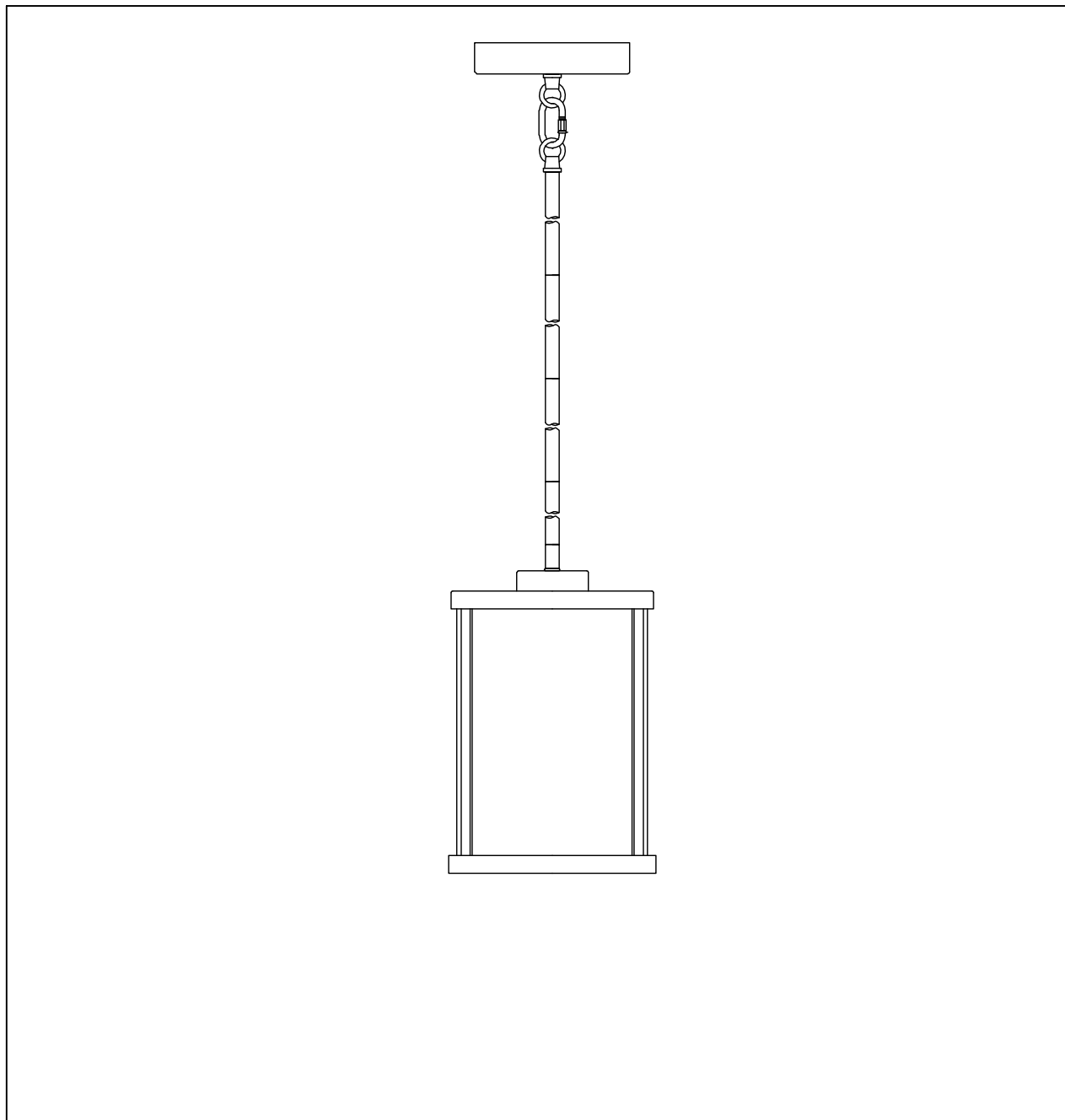







PRODUCT NAME: Centennial 1-Light Mini Pendant
ITEM NUMBER: 25252

Please consult your electrician for hanging fixture and wiring.

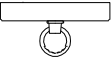

Bulb(not included): 1-60 Watt Medium Base Bulbs

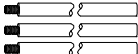
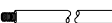
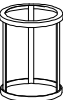
IMPORTANT: Turn off the power at the main fuse or circuit breaker box before starting installation

- | | | | | |
|---|---|---|---|---|
|  |  |  |  |  |
| A
Crossbar(1pc) | B
Screw(2pcs) | C
Canopy & Loop (1pc) | D
Finial(1pc) | E
Hook & Loop(1pc) |
|  |  |  |  |  |
| F
Stem (3pcs) | G
Stem (1pc) | H
Metal Frame(1pc) | I
Glass(1pc) | J
Socket Ring(1pc) |
- Locate all hardware & components before discarding packaging**

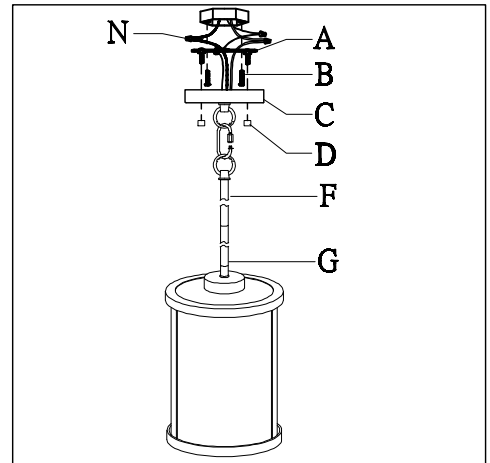
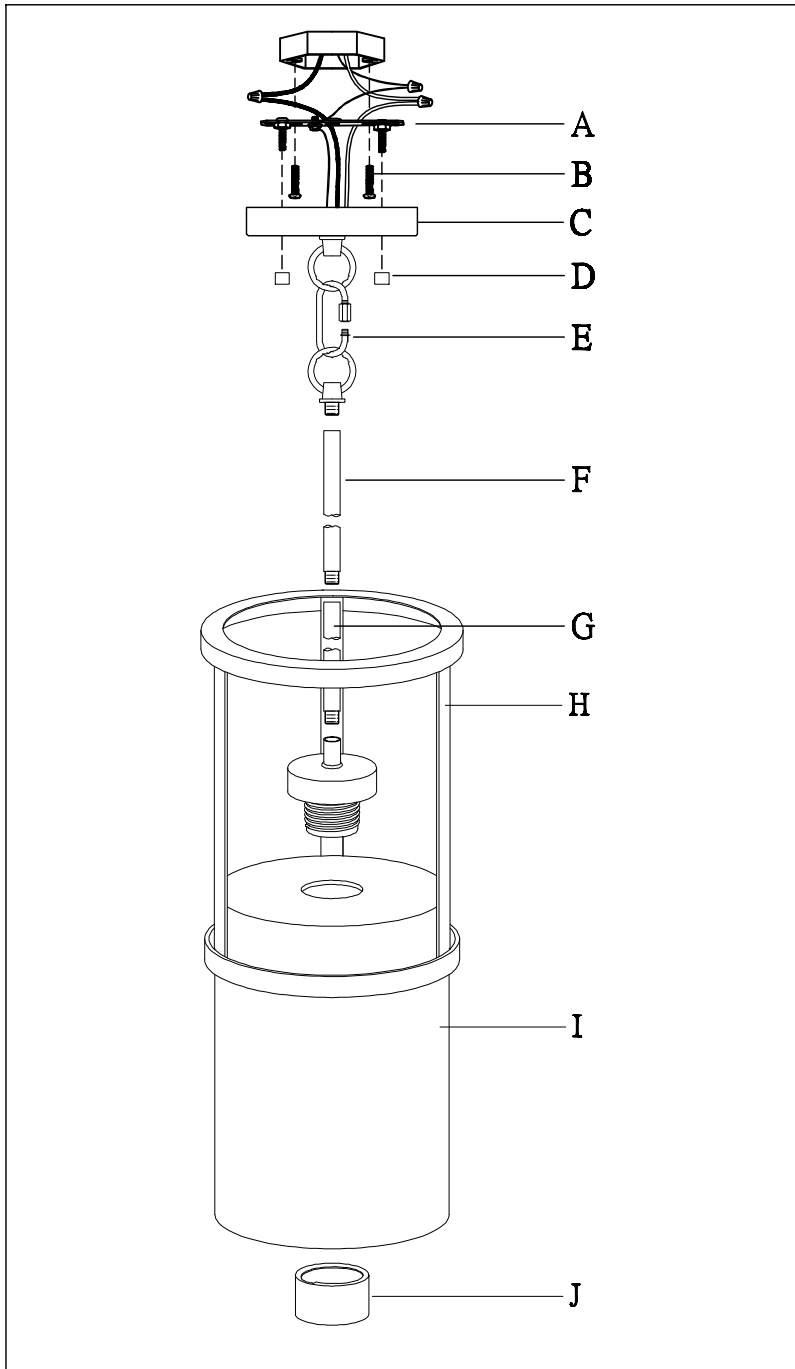

1.)

Step 1: Remove crossbar(A) from fixture and install to electrical box
 Run wire through stems and combine stem lengths to meet desired mounting height.
 Wire fixture to wires in outlet box.
 Green wire is for Ground.
 Install fixture to crossbar(A) and tighten by screws and finial(D) of the canopy to secure.

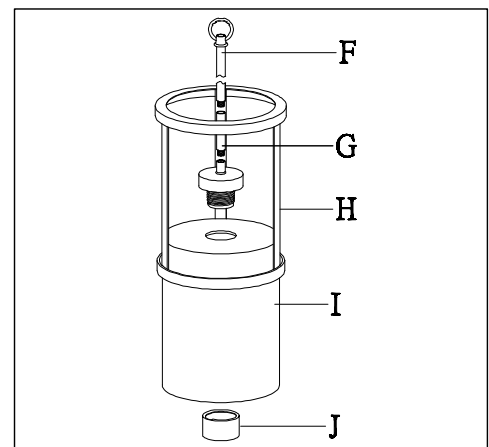

2.)

Step 2: Attach the glass (I) to the frame (H) by threading the socket ring (J).

Cleaning & Care:

Clean with soft cloth and a mild detergent.
 Do not use abrasive cleaner.