

Please consult your electrician for hanging fixture and wiring.

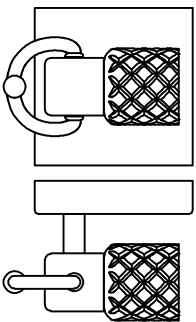

The fixture is designed to dim with a standard Triac forward phase dimmer. Dimming levels will vary by dimmer.
The above belongs in box with recommended driver.

Below is a list of recommended dimmers:

- Lutron MACT-153M
- Lutron DYL-153P
- Lutron SCL-153P
- Leriton IPL06-10Z
- Leriton 6674-POW

Due to inrush current voltage should not exceed 150 volts of product a 600 watt dimmer.

WARNING: WIRES NEED TO BE CONNECTED TO DRIVER FOUND IN CANOPY AND SHOULD NOT CONNECT DIRECTLY TO POWER SOURCE OR A SHORT MIGHT OCCUR.

1*2.5W LED

IMPORTANT! Turn off the power at the main fuse or circuit breaker box before starting installation



(A)
Mounting Bracket

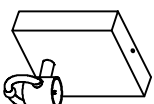

(B)
Body



(C)
Crystal

Locate all hardware & components before discarding packaging

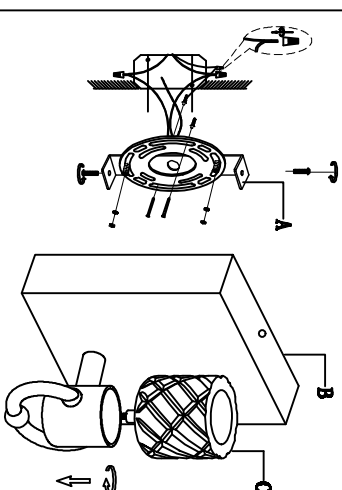

1.)

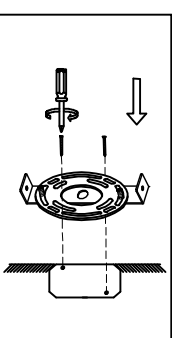

Step 1: Remove mounting bracket (A) from fixture and install to electrical box.

2.)

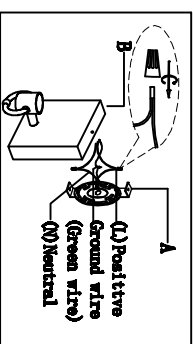

Step 2: Wire fixture to wires in outlet box. Green wire is for Ground.

3.)

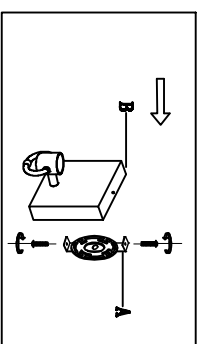

Step 3: Install Body (B) to Mounting Bracket (A) and tighten screws at the ends of the canopy to secure.

4.)

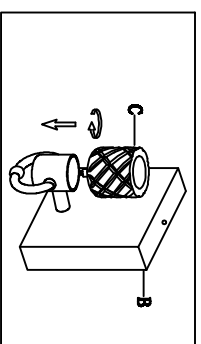

Step 4: screw the crystal (C) onto the lamp holder.

Cleaning & Care:
Clean with soft cloth and a mild detergent.
Do not use abrasive cleaner.