

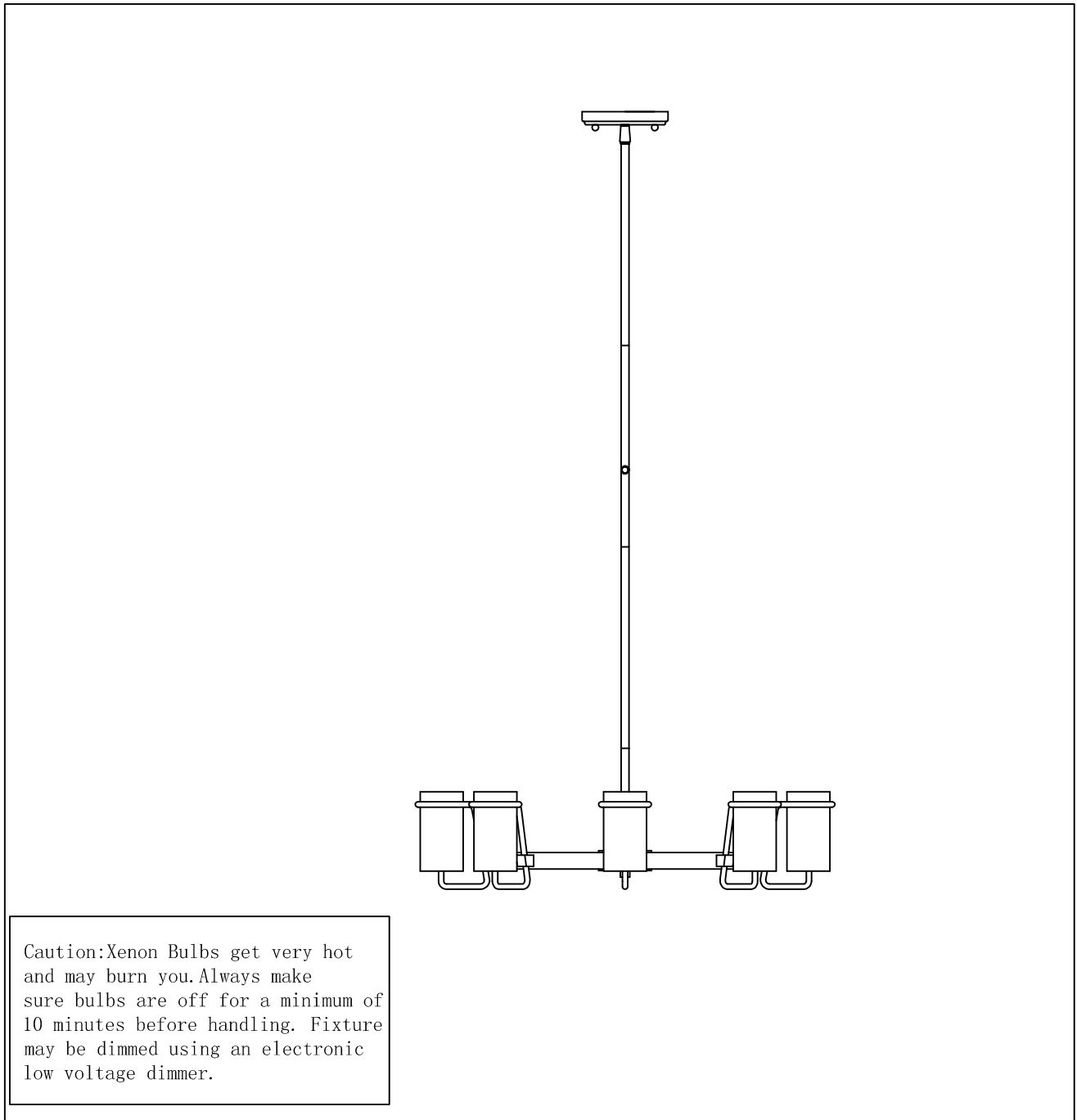

PRODUCT NAME: Avant 8LT Chandelier
NUMBER: 22029

Please consult your electrician for Hang fixture and wiring.



Caution: Xenon Bulbs get very hot and may burn you. Always make sure bulbs are off for a minimum of 10 minutes before handling. Fixture may be dimmed using an electronic low voltage dimmer.

Bulb (included) : 8*G9 Xenon Frost 40W

IMPORTANT: Turn off power at the main fuse or circuit breaker box before starting installation

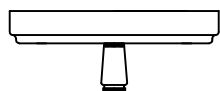

(A) Canopy

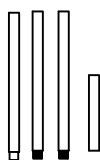

(B) Stems

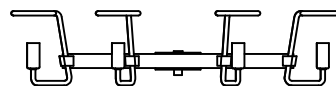

(C) Body

Locate all hardware & components before discarding packaging

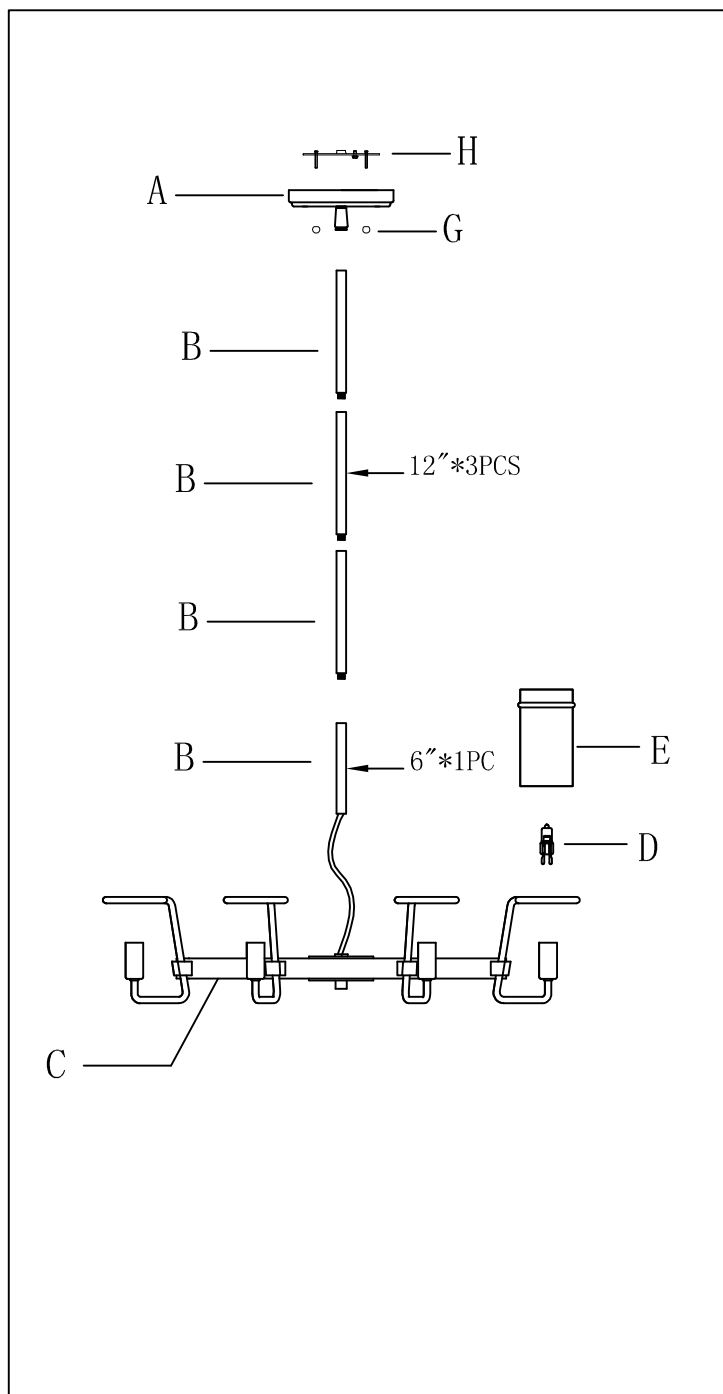

1.)

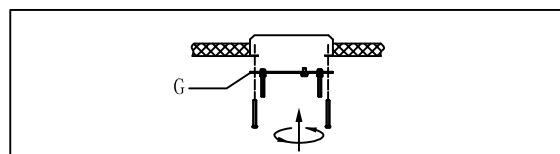

Step. 1: Remove mounting bracket (G) from fixture and install to electrical box.

2.)

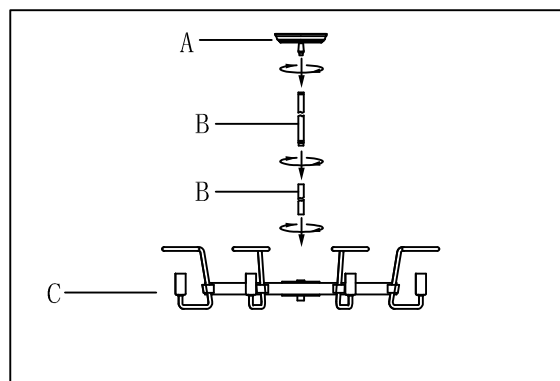

Step. 2: Run wire through stems (B) and combine stem lengths to meet desired mounting height.

3.)

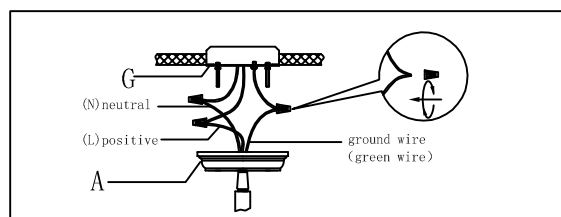

Step. 3: Wire fixture to wires in outlet box. Copper/Green wire is for Ground.

Cleaning & Care:

Clean with soft cloth and a mild detergent.
Do not use abrasive cleaner.

IMPORTANT: Turn off power at the main fuse or circuit breaker box before starting installation



(D) Bulb



(E) Glass



(F) Ball nut



(G) Bracket

Locate all hardware & components before discarding packaging

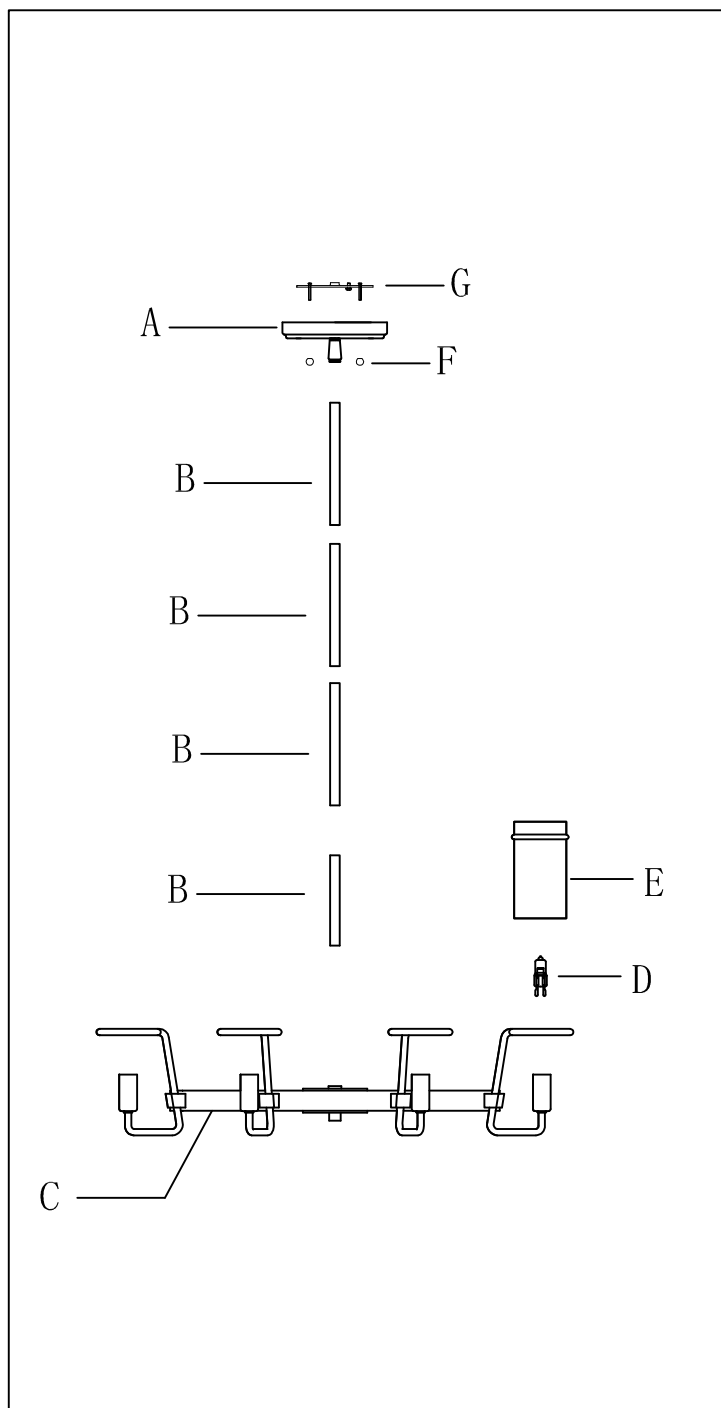

4.)

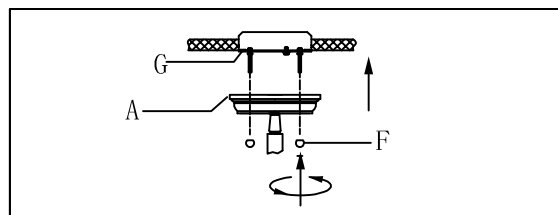

Step. 4: Install fixture to bracket and tighten ball nuts (F) on the canopy to secure.

5.)

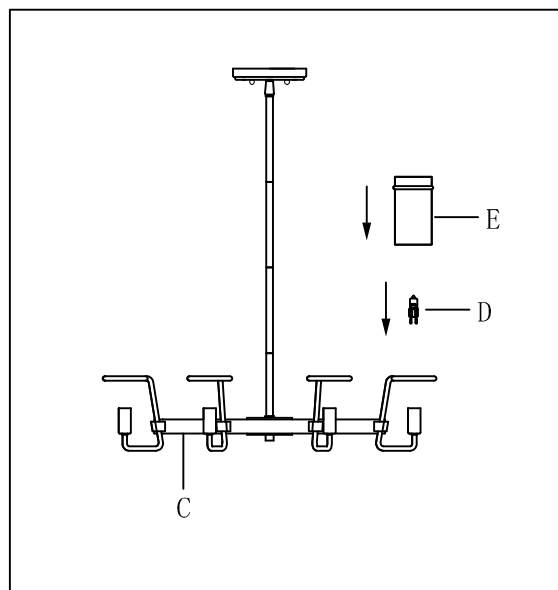

Step. 5: Install bulb (D) on the fixture, and put the glass (E) on the socket.

Cleaning & Care:

Clean with soft cloth and a mild detergent.
Do not use abrasive cleaner.