

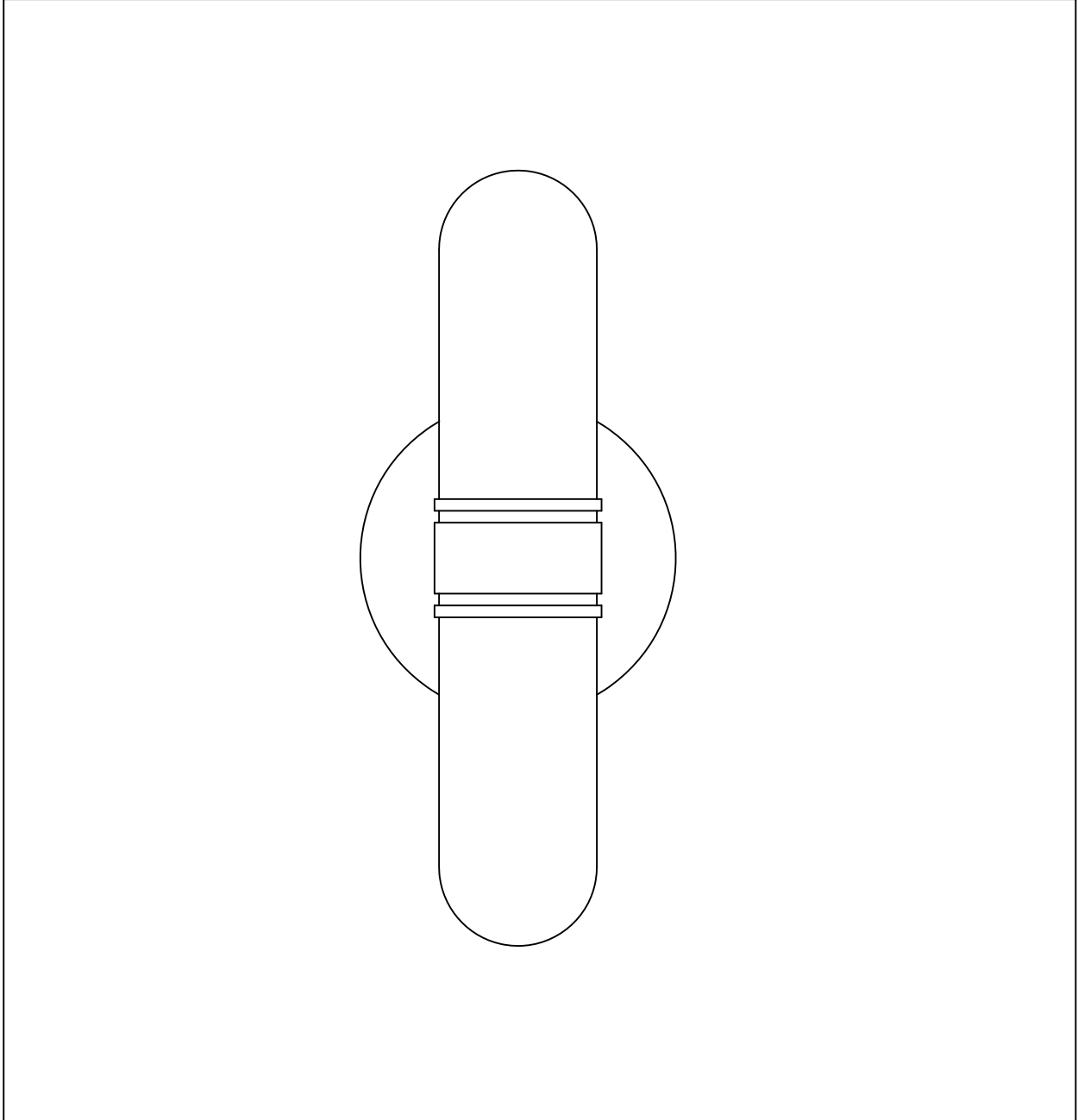

PRODUCT NAME: Dual
ITEM NUMBER: 21702CLBKAL

Please consult your electrician for hanging fixture and wiring.



Bulb Included: 2 x 40W E12 Candelabra

IMPORTANT: Turn OFF the power at the main fuse or circuit breaker box before starting installation



A
Mounting Hardware



B
Back Plate Screws
2PCS

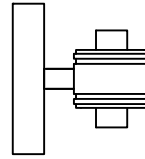

C
Fixture

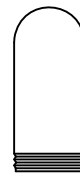

D
Glass 2PCS

Locate all hardware & components before discarding packaging

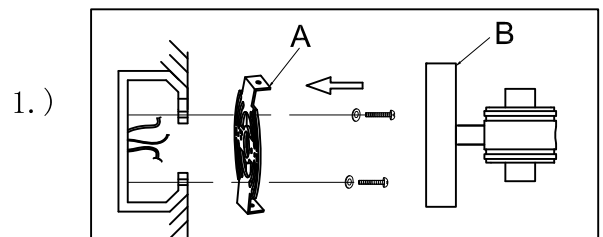
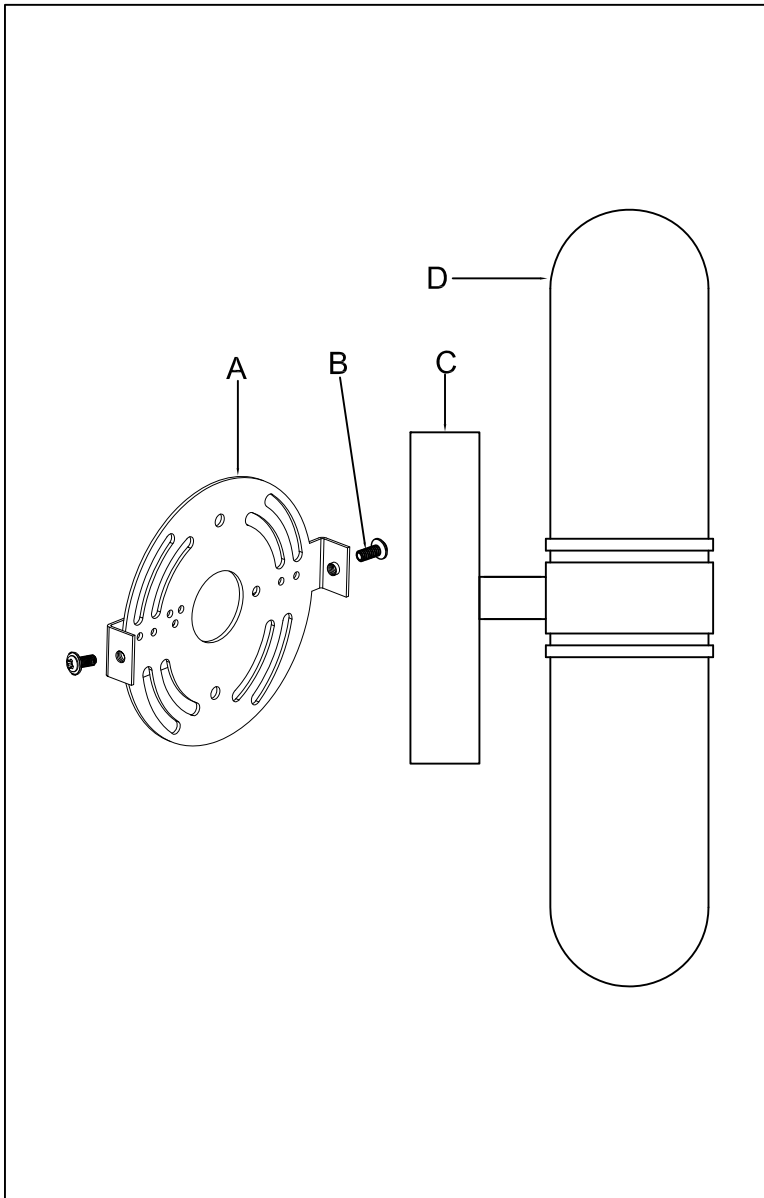

1.)

Step.1: Remove mounting hardware (A) from fixture (C) and install to electrical box.

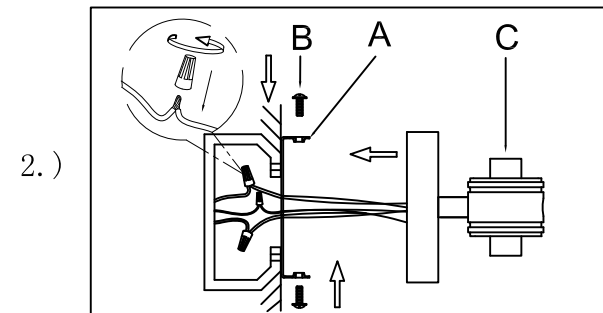

2.)

Step.2: Wire fixture to wires in outlet box. Copper wire is for Ground. Attach fixture (C) to mounting hardware (A) using screws (B) to secure.

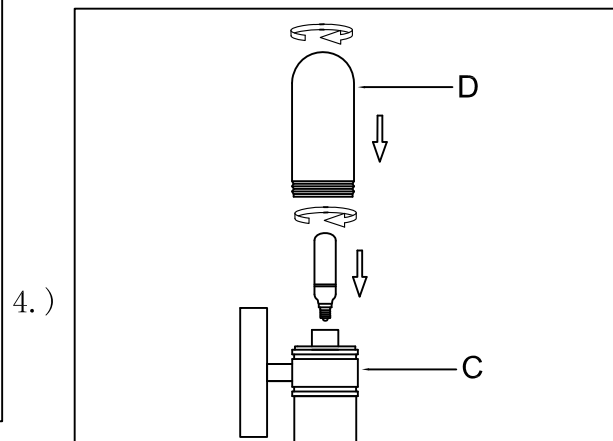

4.)

Step.4 : Install 40 Watt candelabra base bulb. Then, Thread glass (D) into fixture (C).

Cleaning & Care:

Clean with soft cloth and a mild detergent.
Do not use abrasive cleaner.