

PRODUCT NAME: Mingle 4-Light Chandelier  
ITEM NUMBER: 21666

Please consult a qualified electrician for hanging fixture and wiring.

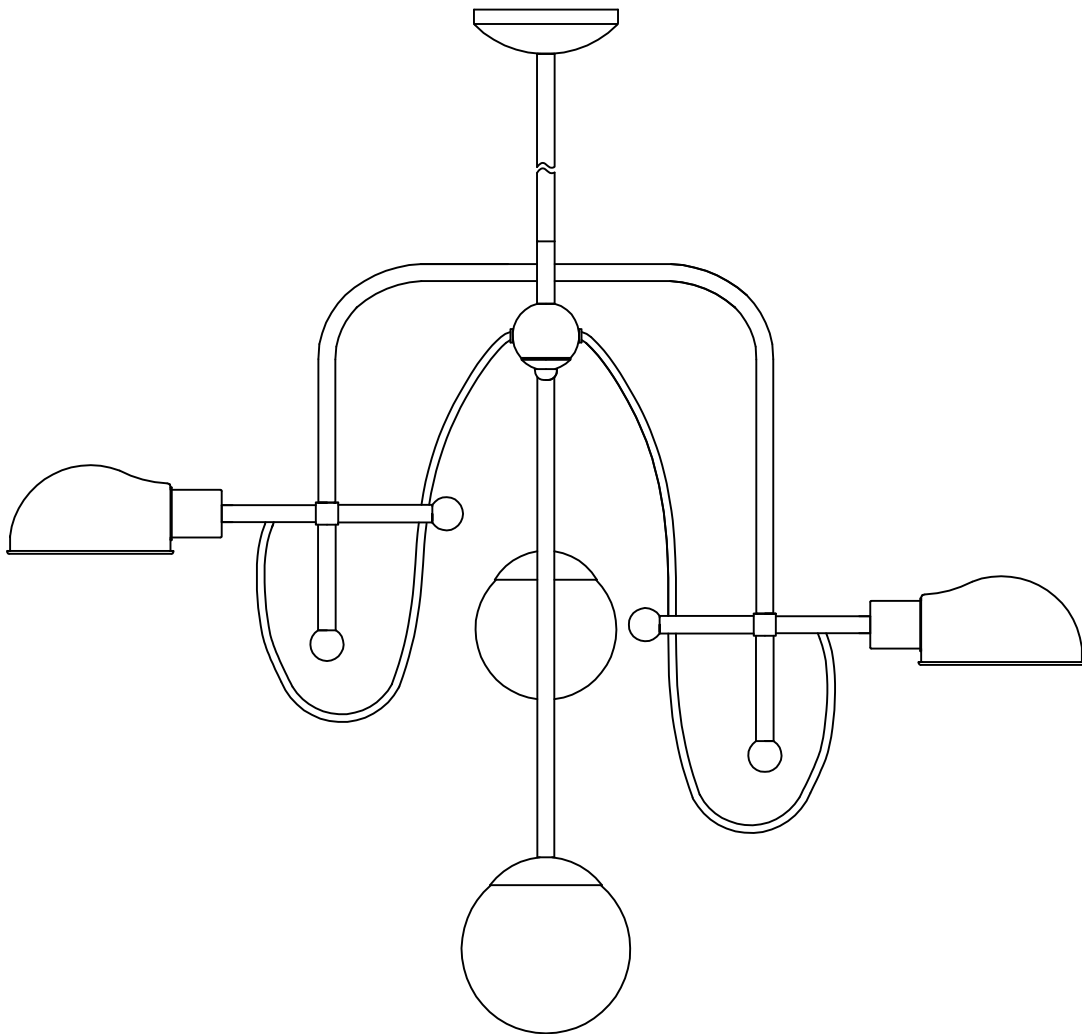

Bulb (included): 2\*4W G9\*LED Bulbs + 2\*9W E26\*LED Bulbs

Bulb (Max wattage): 2\*25W G9 Bulbs + 2\*40W E26 Bulbs

**IMPORTANT:** Turn off the power at the main fuse or circuit breaker box before starting installation

Locate all hardware & components before discarding packaging

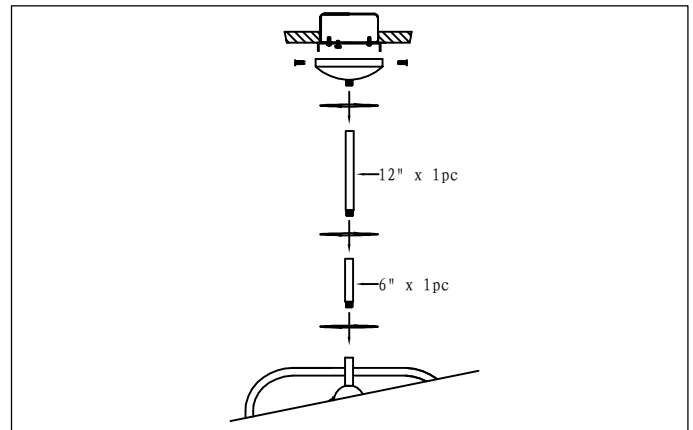
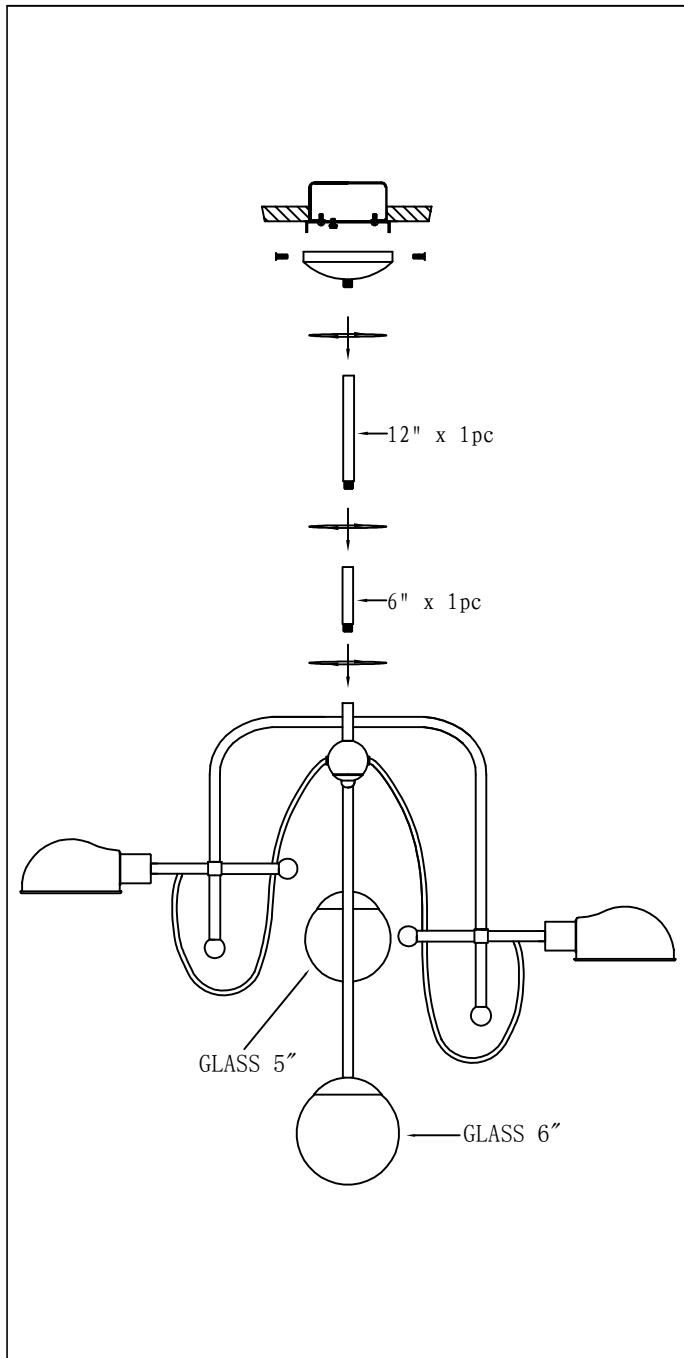

1. Remove mounting bracket from fixture and install to electrical box
2. Run wire through stems and combine stem lengths to meet desired mounting height.

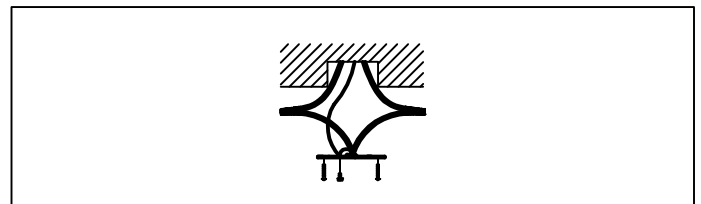

3. Wire fixtures to wires in outlet box. Copper wire is for grounding.

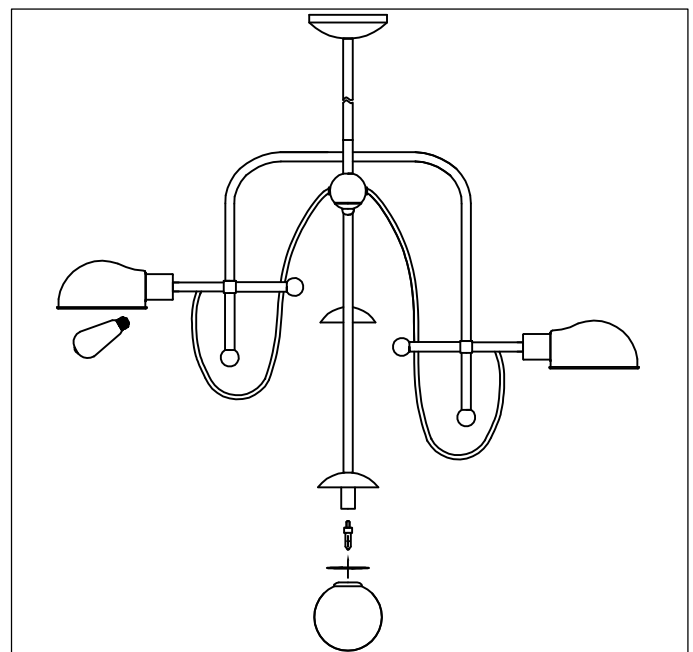

4. Install LED G9 and LED E26 included.
5. Thread glass onto cup.

**Cleaning & Care:**  
Clean with soft cloth and a mild detergent.  
Do not use abrasive cleaner