

## Features

- Catalyzed conversion varnish provides a durable moisture-resistant finish.
- Frameless construction with full-overlay doors and drawers.
- Two doors and one drawer.
- Three-way adjustable slow-close door hinges with 110-degree opening capability for easy cabinet access.
- Optional adjustable shelf / drawer organizer (sold separately).
- Coordinates with other products in the Poplin™ collection.
- Full-extension 18" depth drawers with slow-close under-mount slides for smooth opening.
- Solid wood drawers with dovetail construction.
- Door and drawer pulls are sold separately.

## Material

- Solid wood and veneers.

## Recommended Accessories

K-5455 Bathroom Vanity Top  
K-5421 Bathroom Vanity Top  
K-5436 Bathroom Vanity Top  
K-99686 Knob  
K-99689 Handle

## Optional Accessories

99680  
99679  
K-99665 Framed Mirror  
K-99681 Side Mount Electrical Outlets  
K-99682 General Storage  
K-99683 Makeup Storage  
K-99684 Drawer Dividers  
K-99672 Two-Drawer Bridge  
K-99668 Lap Drawer  
K-99676 Filler Strip  
K-99001 Mirrored Cabinet  
K-99007 Mirrored Cabinet  
K-99009 Mirrored Cabinet  
99678



## Codes/Standards











CARB P2

## KOHLER® One-Year Limited Warranty

See website for detailed warranty information.

## Available Color/Finishes

*Color tiles intended for reference only.*

Color	Code	Description
	1WA	Linen White
	1WF	Khaki White Oak
	1WD	Ramie Walnut
	1WG	Cherry Tweed
	1WB	Claret Suede
	1WH	Woolen Oak
	1WC	Felt Grey
	1WE	Terry Walnut
	1WT	Mohair Grey
	1WU	Batiste Black

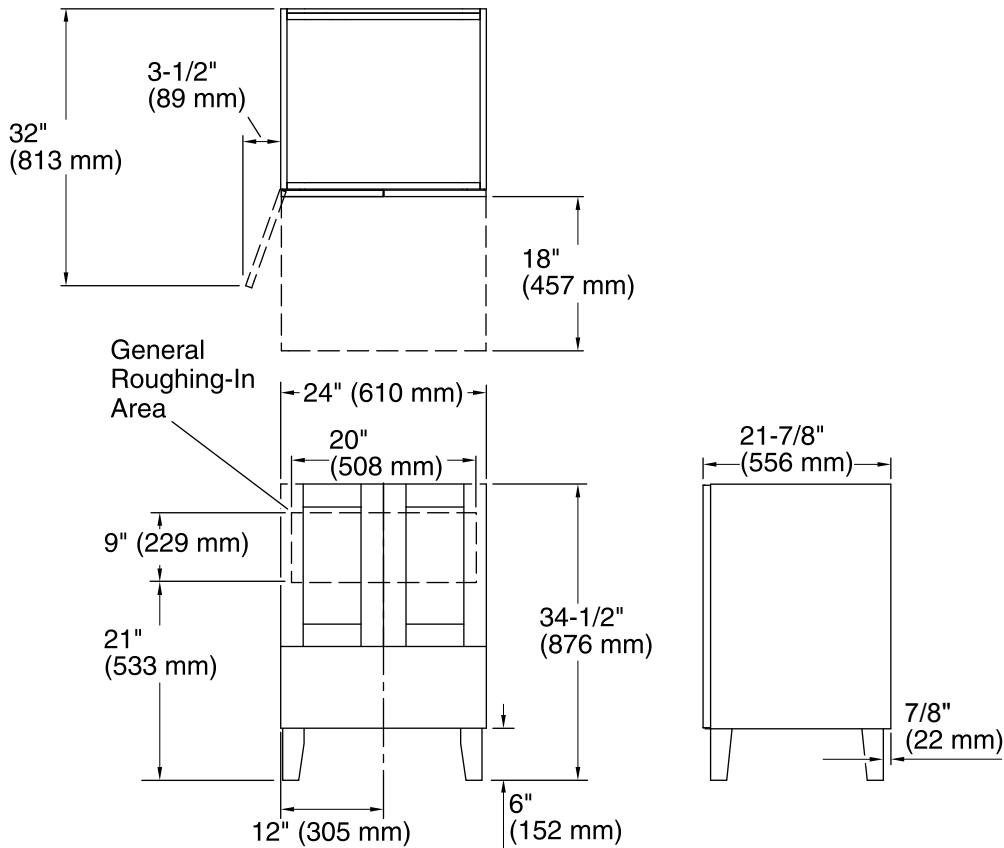

## Technical Information

All product dimensions are nominal.

Vanity type: Standard

## Notes

Install this product according to the installation guide.

Decorative cabinet hardware is not supplied. Refer to the KOHLER bath accessories line for recommended cabinet hardware to complement your vanity.

Select the type of fastener based upon the wall material. Two 250 lb (113.4 kg) minimum load bearing fasteners are recommended.