

Features

- Three adjustable tempered glass shelves.
- Full-overlay mirrored door.
- Mirrored interior.
- Two-way adjustable hinges with 108-degree opening capability for easy cabinet access.
- Can be installed with left- or right-hand swing.
- Includes mounting hardware for surface or recessed installation.
- Requires K-99012 side mirror kit (sold separately) for surface mount installation.

Material

- Anodized aluminum construction with a durable rust-free and chip-free finish.

Optional Accessories

K-99012 Side Mirror Kit



Codes/Standards

None Applicable

KOHLER® One-Year Limited Warranty

See website for detailed warranty information.

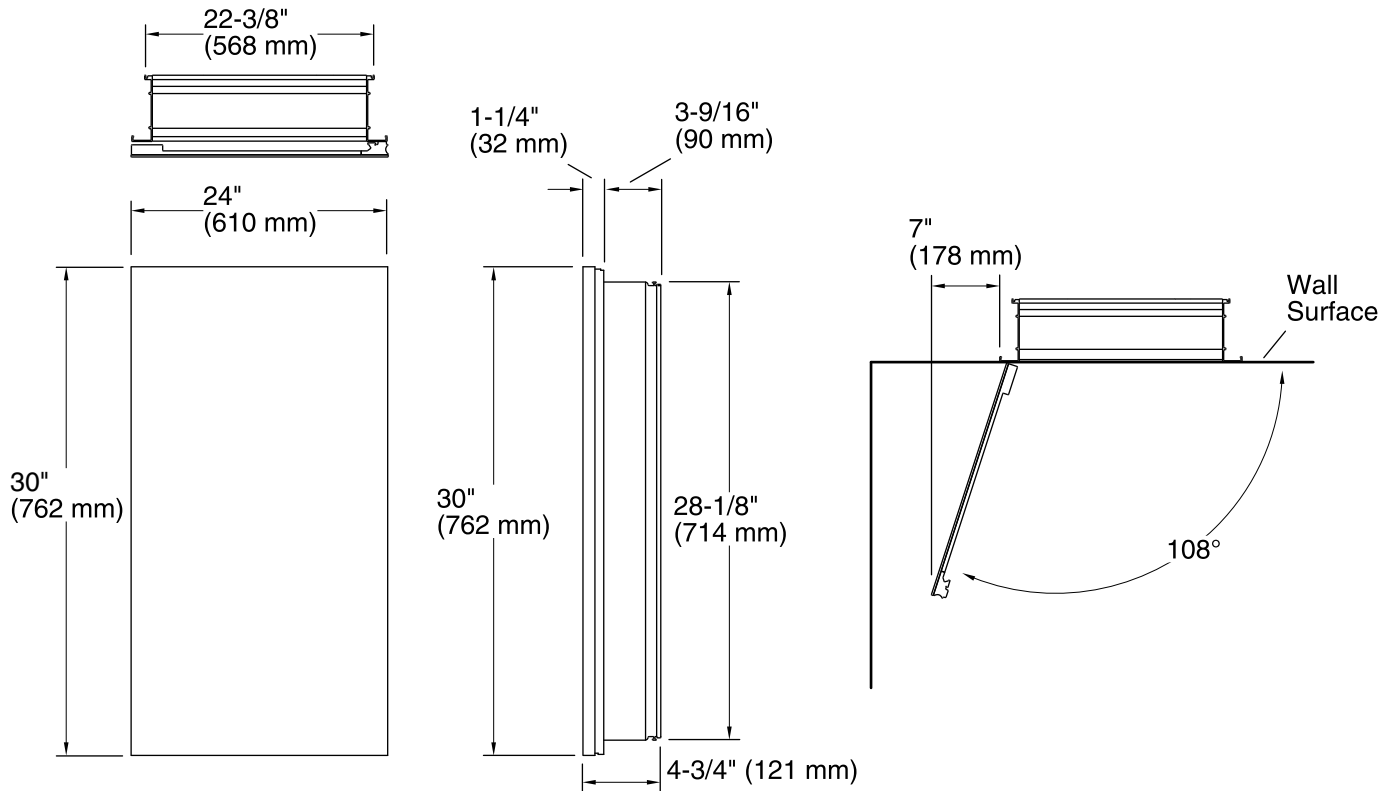

Technical Information

All product dimensions are nominal.

Notes

Install this product according to the installation guide.

IMPORTANT! For recess mounting, the wall cavity must be framed and cabinet secured to framing studs. Reroute any electrical wires or water supply piping from the wall cavity. If you encounter drain or vent piping, or if your wall is load-bearing, consult a professional before proceeding.

For surface mounting, use anchors (not provided) rated for the loaded weight of this product. Refer to the anchor manufacturer's instructions.

When determining the height of the cabinet, ensure the mirrored door will clear all obstacles (such as a faucet). A minimum distance of 3" (76 mm) is required.

This cabinet is designed for either right or left door swing. Check for obstructions.

Cutout for recess-mount installations: 22-1/2" (572 mm) width x 28-1/4" (718 mm) height x 3-11/16" (94 mm) depth.