

Features

- 33-inch minimum base cabinet width.
- 4 faucet holes (-4).
- Includes cutout templates.
- 5-1/4 inch depth.
- Single bowl.

Material

- KOHLER enameled cast iron.

Installation

- Top-mount

Recommended Accessories

K-9000 P-Trap

Optional Accessories

K-8801 Sink Strainer



ADA

Codes/Standards











ASME A112.19.1/CSA B45.2
ADA
ICC/ANSI A117.1

KOHLER® Enameled Cast Iron Kitchen Sink - Lifetime Limited Warranty

See website for detailed warranty information.

Available Color/Finishes

Color tiles intended for reference only.

Color	Code	Description
	0	White
	FF	Sea Salt™
	96	Biscuit
	47	Almond
	FD	Cane Sugar™
	95	Ice™ Grey
	G9	Sandbar
	K4	Cashmere
	20	Suede
	KA	Black 'n Tan
	7	Black Black™

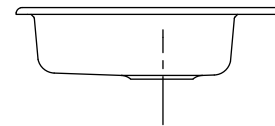
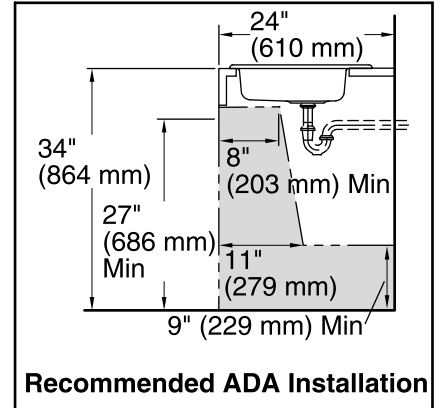
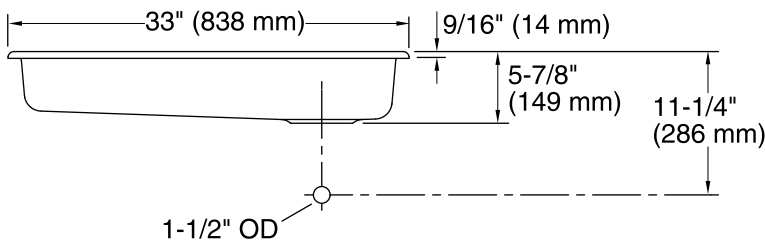
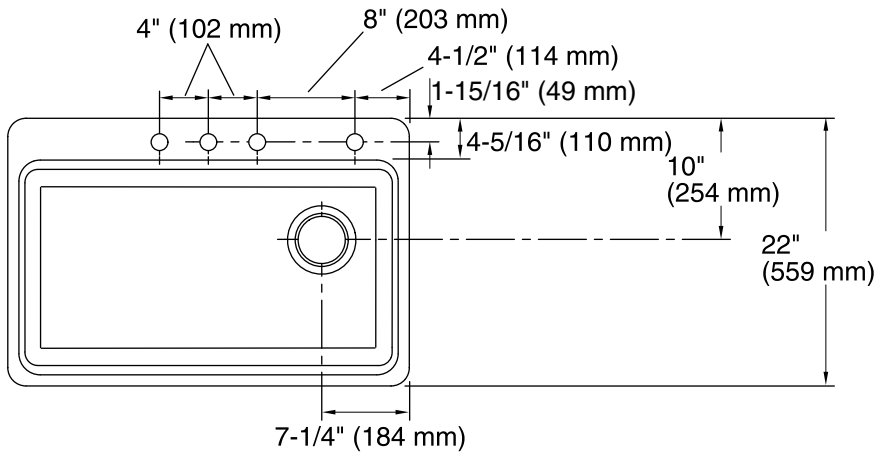

Technical Information

All product dimensions are nominal.

- Bowl configuration: Single
- Installation: Top-mount, Top-mount
- Bowl area (Only)
 - Length: 30-1/4" (769 mm)
 - Width: 17-1/4" (438 mm)
 - Bowl depth: 5-1/4" (133 mm)
 - Water depth: 5-1/4" (133 mm)
- Template: 1166727-7, required, included

Notes

- Install this product according to the installation instructions.
- ADA compliant when installed to the specific requirements of these regulations.