

Features

- Rectangular basin.
- Overflow drain.

Material

- KOHLER® enameled cast iron.

Installation

- No faucet holes; requires wall-or counter-mount faucet.
- Drop-in or undermount.

Recommended Products/Accessories

- K-23726 Drain treatment
- K-23725 Cast iron cleaner

Optional Products/Accessories

- 52047 Clamp Accessory Pack, 4 Ea.

Included Components

- Additional Components:
 - 1193643 Basin clamps



ADA CSA B651

Codes/Standards















ASME A112.19.1/CSA B45.2
ADA
ICC/ANSI A117.1
CSA B651

Lifetime Limited Warranty for KOHLER® Cast Iron Components

See website for detailed warranty information.

Available Colors/Finishes

Color tiles intended for reference only.

| Color | Code | Description |
|--|------|---------------|
|  | 0 | White |
|  | FF | Sea Salt™ |
|  | 96 | Biscuit |
|  | 47 | Almond |
|  | FD | Cane Sugar™ |
|  | NY | Dune |
|  | G9 | Sandbar |
|  | KC | Vapour™ Blue |
|  | KG | Vapour™ Green |
|  | K4 | Cashmere |
|  | FT | Basalt |
|  | 20 | Suede |
|  | KA | Black 'n Tan |
|  | 7 | Black Black™ |

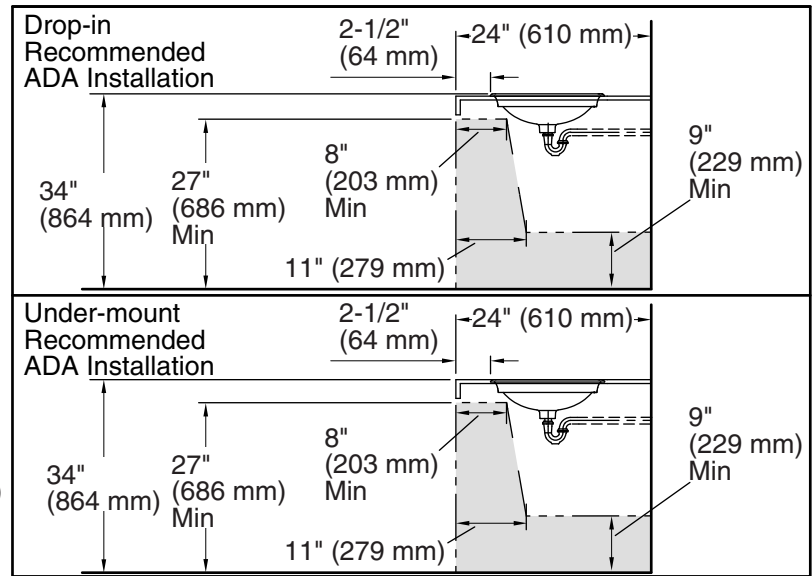
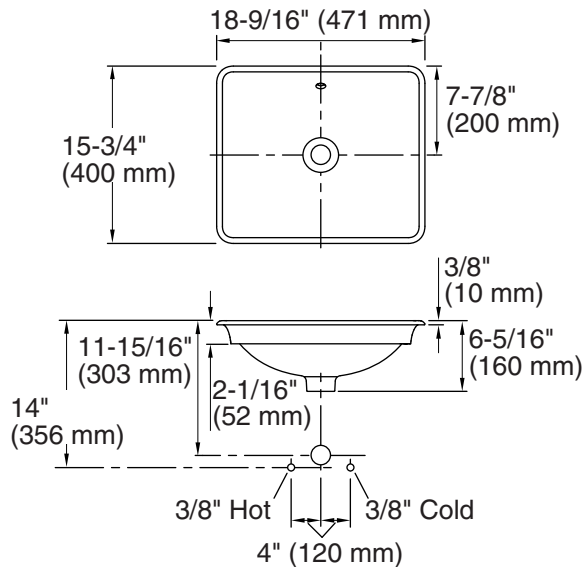

Technical Information

All product dimensions are nominal.

| | |
|---------------------|--|
| Bowl configuration: | Single |
| Installation: | Drop-in, Under-mount |
| Bowl area (Only): | Length: 17-1/2" (445 mm) Width: 14-3/4" (375 mm) Bowl depth: 4-9/16" (116 mm) With overflow: Yes Water depth: 2-15/16" (74 mm) |
| Template: | 1222632-7, required, included |

Notes

Install this product according to the installation instructions.

NOTICE: Countertop manufacturer or cutter must use the cut-out template provided with the product, or a current one provided by Kohler Co. (call 1-800-4-KOHLER). Kohler Co. is not responsible for cutout errors when the incorrect cut-out template is used.

ADA, CSA B651 compliant when installed to the specific requirements of these regulations.