

Features

- Vitreous china.
- Comfort Height® Elongated bowl.
- AquaPiston® flushing system.
- Includes left-hand polished chrome trip lever.
- 1.28 gpf (4.8 lpf).
- Skirted trapway.
- 2-1/8" (54 mm) fully glazed trapway.
- Patented ReadyLock™ installation system
- 12" (305 mm) rough-in.
- Less seat and supply.
- 9-1/2" (241 mm) x 6-1/2" (165 mm) water area.
- 29" (737 mm) x 17-3/4" (451 mm) x 30-3/10" (770 mm).
- Floor mount / Floor outlet.

Optional Accessories

- K-7637 Angle Supply with Stop (single)
- K-4636 Toilet Seat
- K-4731-C Commercial Heavy-duty Toilet Seat
- K-5383 10" Rough-in Full Skirt Trap and Attachment System
- K-5381 14" Rough-in Full Skirt Trap and Attachment System

Components

Product includes:

- K-5309 Skirted Trapway Bowl
- K-4369 Toilet Tank
- Additional included component/s: Tank cover, Trip lever, and ReadyLock™ installation system.



ADA **CSA B651** **OBC**







Codes/Standards

ASME A112.19.2/CSA B45.1
DOE - Energy Policy Act 1992
EPA WaterSense®
California Energy Commission (CEC)
ADA
ICC/ANSI A117.1
CSA B651
OBC

See website for detailed warranty information.

Available Color/Finishes

Color tiles intended for reference only.

Color	Code	Description
	0	White
	96	Biscuit
	47	Almond
	NY	Dune
	95	Ice™ Grey
	G9	Sandbar
	7	Black Black™

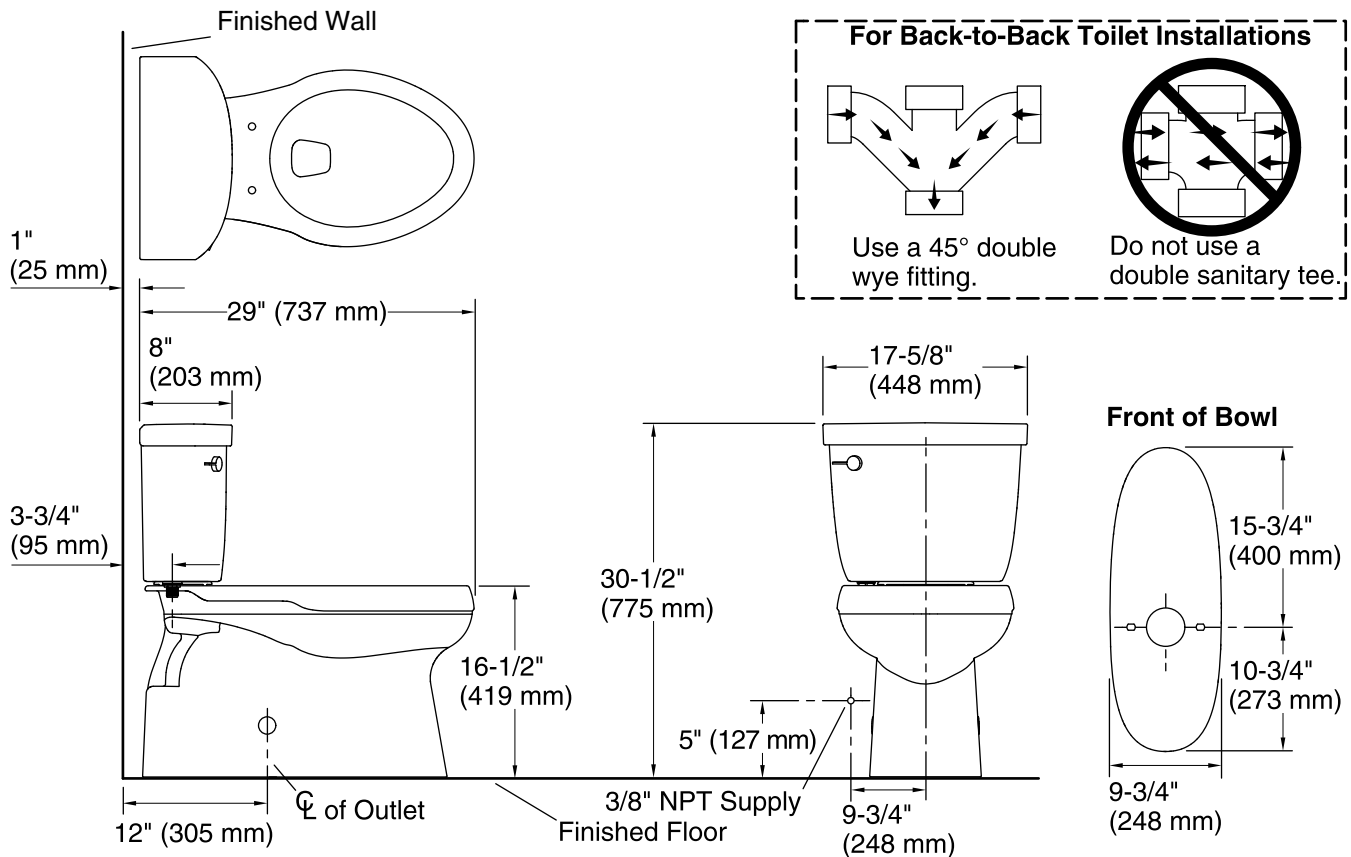

Technical Information

All product dimensions are nominal.

Toilet type: Two-piece

Trap passageway: 2-1/8" (54 mm)

Water Consumption

Full: 1.28 gpf (4.8 lpf)

Water surface size: 9-5/8" x 6-5/8" (244 mm x 168 mm)

Rim to water surface: 6-3/8" (163 mm)

Rough-in: 12" (305 mm)

Fixture Supply Requirements

Min static pressure: 15 psi (103.4 kPa)

Notes

Install this product according to the installation instructions.

For back-to-back toilet installations: Use only a 45° double wye fitting.

ADA, OBC, CSA B651 compliant when installed to the specific requirements of these regulations.

Plumbing Codes require elongated toilets and elongated, open-front toilet seats in public bathrooms.

Accessibility standards require controls to be located on the open side of the toilet.