

Features

- Column lets you customize your shower with a rainhead and handshower.
- Arched shower arm makes it possible to install with low ceiling heights.
- Patent-pending technology allows for an easy bath/shower installation.
- Slidebar bracket allows you to adjust height and angle of handshower.
- Diverter at the base of the column makes for easy toggling between handshower and rainhead.
- Rainhead and handshower sold separately to allow for customized components.
- Developed and optimized for use with KOHLER handshowers and KOHLER Katalyst™ rainheads K-13688, K-13689, K-13692, and K-13695 (sold separately).
- KOHLER finishes resist corrosion and tarnishing.

Material

- Premium metal construction.

Installation

- Wall-mount bath or shower installation.
- Installs in less than 60 minutes without changes to in-wall plumbing (subject to condition of existing installation).
- May require additional service parts based on installation type (see installation guide or specification sheet for details).
- Includes an adapter that will fit with most installations but may require one or more kits (sold separately).

Recommended Accessories

1187917 1/2" NPT Shallow Rough-in Kit
1194302 Large Escutcheon/Mounting Collar Kit
1194630 1/2" NPT Deep Rough-in Kit

Installed component/s: Column, Bracket, Hose, and Slidebar.



ADA CSA B651 OBC

Codes/Standards







ASME A112.18.1/CSA B125.1
ADA
ICC/ANSI A117.1
CSA B651
OBC

KOHLER® Faucet Lifetime Limited Warranty

See website for detailed warranty information.

Available Color/Finishes

Color tiles intended for reference only.

Color	Code	Description
	CP	Polished Chrome
	SN	Vibrant® Polished Nickel
	BN	Vibrant® Brushed Nickel
	BV	Vibrant® Brushed Bronze
	2BZ	Oil-Rubbed Bronze
	TT	Vibrant Titanium

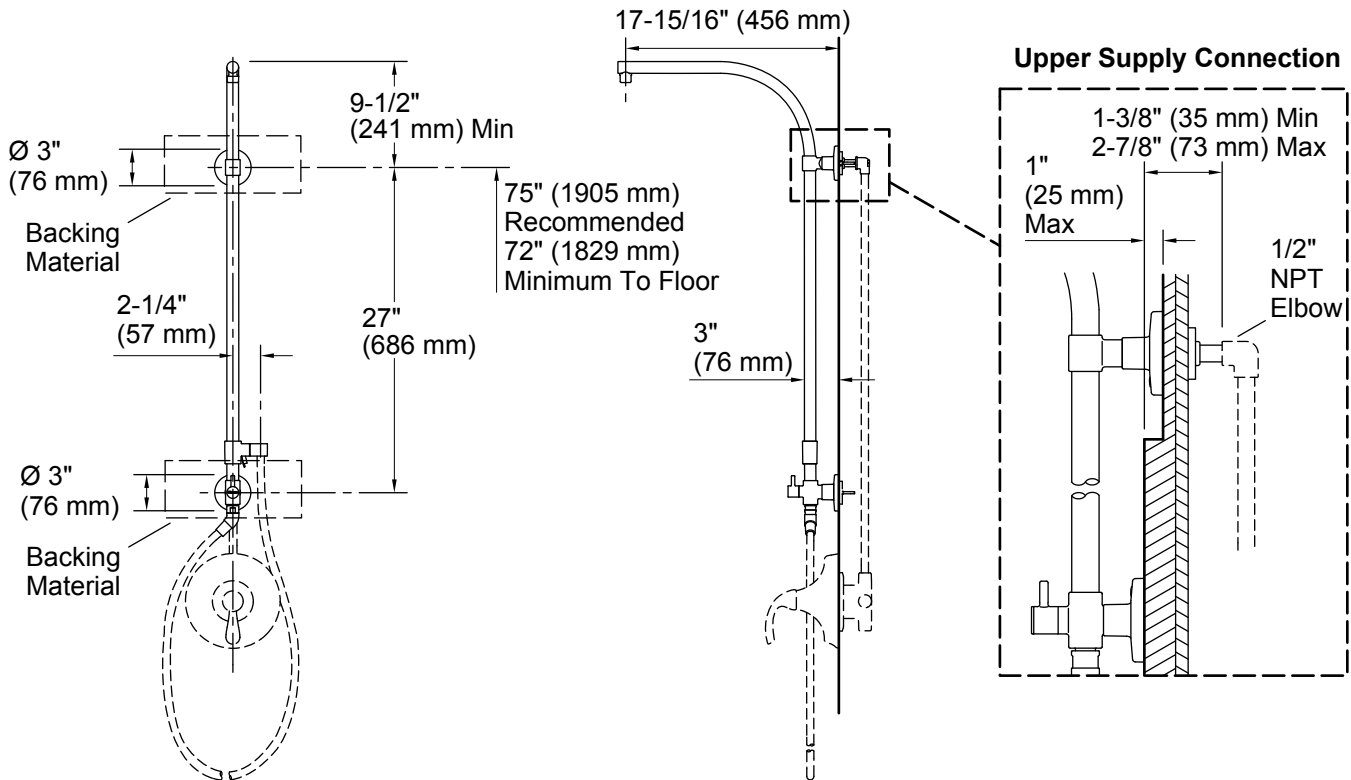

NOTE: Valve trim and hose illustrated for dimensioning only, not included in the product.

Technical Information

All product dimensions are nominal.

Notes

Install this product according to the installation guide.

Order deep roughing-in kit 1194630 if the distance from the elbow to the finished wall surface is between $2\text{-}7/8''$ (73 mm) to $4''$ (102 mm).

Order shallow roughing-in kit 1187917 if the distance from the elbow to the finished wall surface is less than $1\text{-}3/8''$ (35 mm).

A $3''$ (76 mm) escutcheon/mounting collar is supplied to fit a $1''$ (25 mm) to $1\text{-}1/4''$ (32 mm) supply connection hole diameter. Order 1194302 large escutcheon/mounting collar kit if the supply connection hole diameter is between $1\text{-}1/4''$ (32mm) to $2\text{-}1/4''$ (57 mm).

ADA, OBC, CSA B651 compliant when installed to the specific requirements of these regulations.