

Features

- Minimum 27-inch base cabinet width.
- Single bowl.
- 9-1/2-inch depth provides generous workspace.
- No faucet holes.
- Includes K-80037 bottom sink rack.
- Includes cutout templates and installation clips.

Material

- KOHLER Neoroc® composite is durable and built to withstand day-to-day cleaning tasks.
- Matte finish offers rich, dimensional color.
- Solid color throughout the sink.
- Heat resistant up to 750°F.
- Scratch, stain, chip, and thermal-shock resistant.

Installation

- Undermount.
- Easy to install in a one-person, single-day project.

Recommended Products/Accessories

K-8801 Sink Strainer
K-8799 Sink Strainer
K-23726 Drain treatment
K-23730 Neoroc® cleaner

Optional Products/Accessories

K-11352 Disposal Flange with Stopper
K-9000 P-Trap

Included Components

Product consists of:
K-80037 Sink Rack



Codes/Standards









CSA B45.5/IAPMO Z124

KOHLER® Neoroc® Sinks Lifetime Limited Warranty

See website for detailed warranty information.

Available Colors/Finishes

Color tiles intended for reference only.

Color	Code	Description
	CM6	Matte White
	CM7	Matte Graphite
	CM5	Matte Beige
	CM8	Matte Black Plum
	CM1	Matte Black
	CM2	Matte Brown
	CM3	Matte Toupe
	CM4	Matte Grey

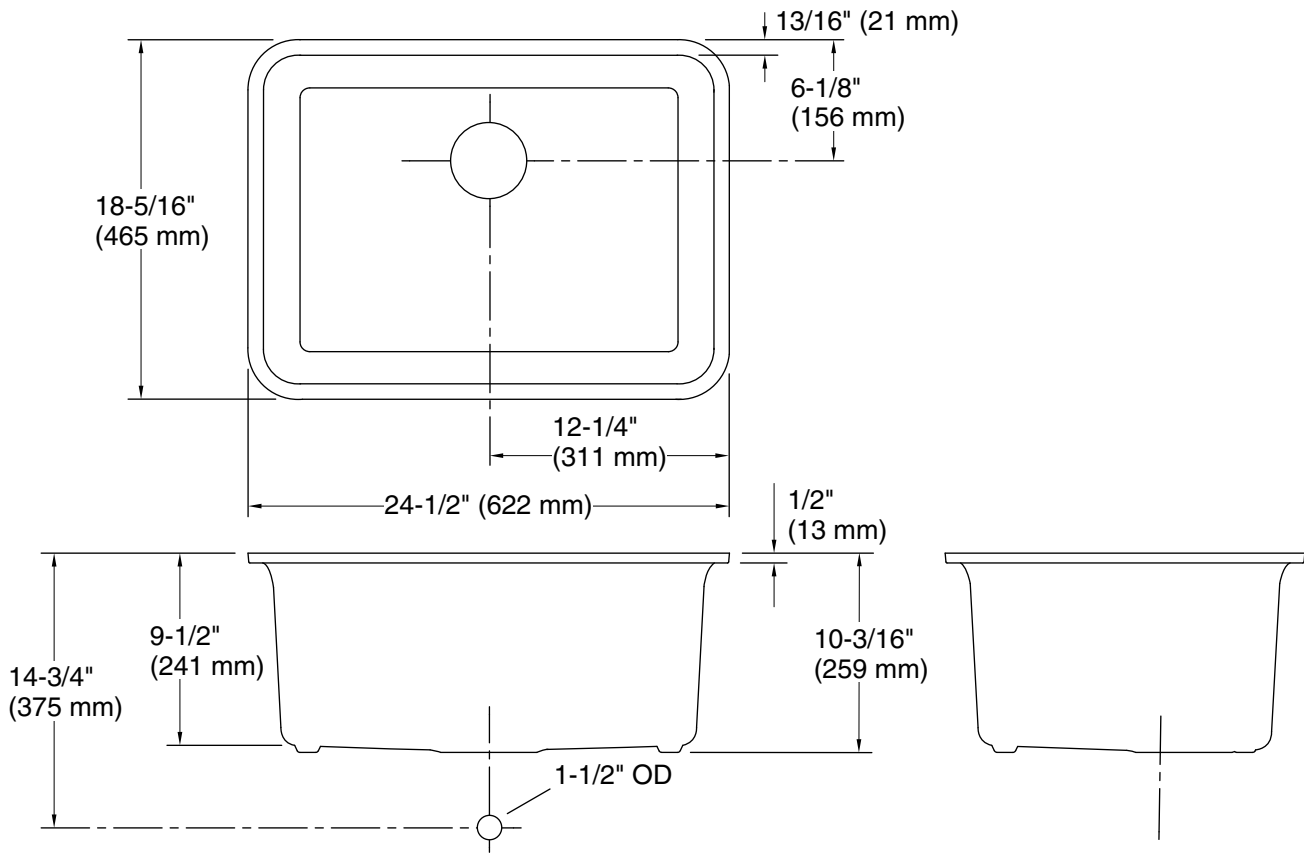

Technical Information

All product dimensions are nominal.

Min. base cabinet width: 27" (686 mm)

Bowl area (Only):
 Length: 22-9/16" (573 mm)
 Width: 16-3/8" (416 mm)
 Bowl depth: 9-1/2" (241 mm)
 Water depth: 9-1/2" (241 mm)

Template: 1316451-7, required, included

Notes

Install this product according to the installation instructions.

Countertop manufacturer or cutter must use the cut-out template provided with the product, or a current one provided by Kohler Co. (call 1-800-43-FOCUS). Kohler Co. is not responsible for cut-out errors when the incorrect cut-out template is used.