

Features

- Single lever handle allows for both volume and temperature control
- 5" (127 mm) spout reach.
- 1.2 gal/min (4.5 l/min) maximum flow rate [max at 60 psi (4.14 bar)].
- Includes metal pop-up drain with 1-1/4" tailpiece.
- Temperature memory allows faucet to be turned on and off at any temperature setting.
- KOHLER ceramic disc valves exceed industry longevity standards for a lifetime of durable performance.
- Coordinates with Fairfax faucets, accessories, and showering components to complete your bathroom.

Material

- Premium Metal Construction.
- KOHLER finishes resist corrosion and tarnishing.

Installation

- For single-hole installation.
- Pre-attached flexible supply lines simplify installation

Optional Products/Accessories

78205 Fairfax Single-handle Plug Button



ADA **CSA B651** **OBC**

Codes/Standards

ASME A112.18.1/CSA B125.1

NSF/ANSI 61

NSF/ANSI 372

All applicable US Federal and State material regulations

DOE - Energy Policy Act 1992

EPA WaterSense®

California Energy Commission (CEC)

ADA

ICC/ANSI A117.1

CSA B651







OBC

KOHLER® Faucet Lifetime Limited Warranty

See website for detailed warranty information.

Available Colors/Finishes

Color tiles intended for reference only.

Color	Code	Description
	CP	Polished Chrome
	PB	Vibrant® Polished Brass
	G	Brushed Chrome
	BN	Vibrant® Brushed Nickel
	BV	Vibrant® Brushed Bronze
	BRZ	Oil-Rubbed Bronze

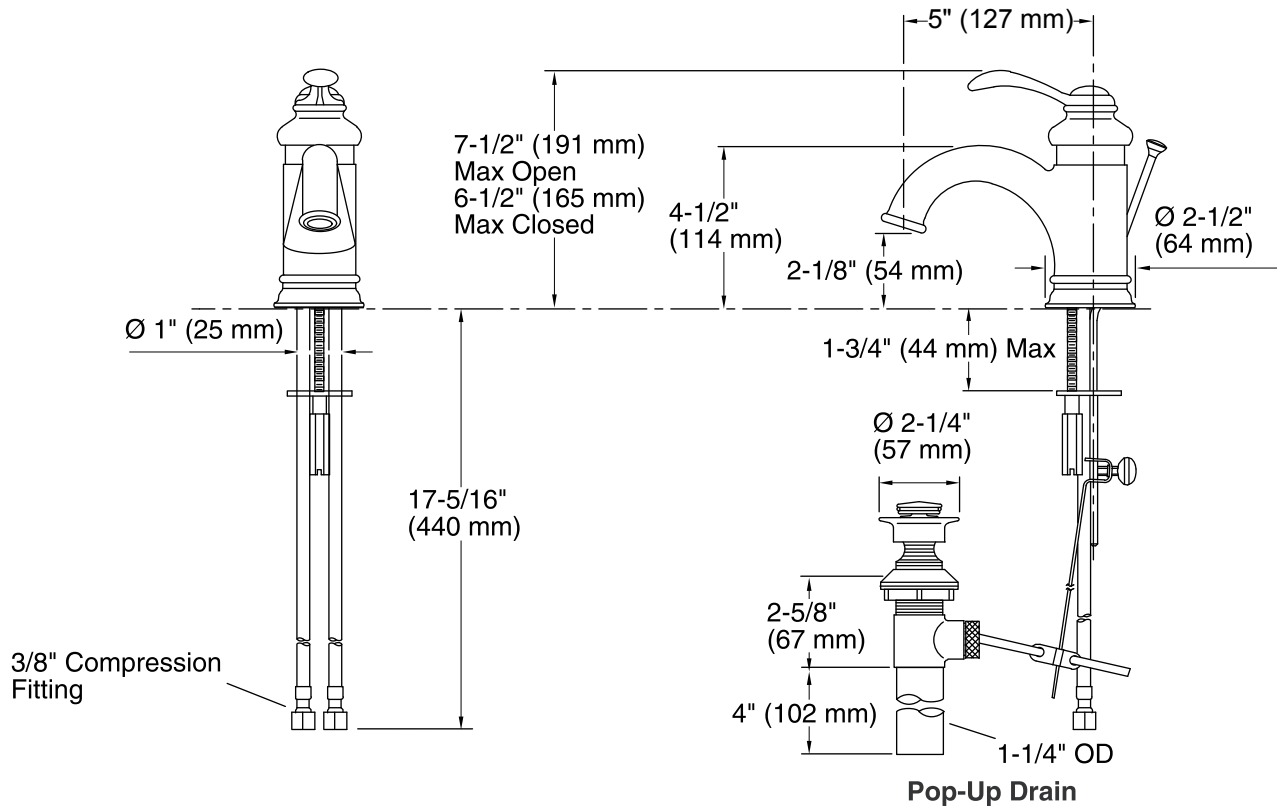

Technical Information

All product dimensions are nominal.

Faucet:

Flow rate: 1.2 gal/min (4.5 l/min)

Pressure: 60 psi (4.1 bar)

Drain included: Yes

Drain tailpiece included: Yes

Spout:

Spout reach: 5" (127 mm)

Notes

Install this product according to the installation guide.

ADA, OBC, CSA B651 compliant when installed to the specific requirements of these regulations.