

### Features

- A single handle controls both on/off activation and temperature setting.
- 11-7/16" (290 mm) spout reach.
- 7.5 gpm (28.4 lpm) maximum bath faucet flow rate at 45 psi (3.1 bar).
- 1.75 gpm (6.6 lpm) maximum handshower flow rate at 80 psi (5.5 bar).
- KOHLER ceramic disc valves exceed industry longevity standards for a lifetime of durable performance.
- Coordinates with other products in the Tone collection.

### Material

- Premium metal construction for durability and reliability.
- KOHLER finishes resist corrosion and tarnishing.

### Installation

- Floor-mount.

### Required Products/Accessories

For freestanding installation  
K-97339 Multiproduct Mounting-block

### Recommended Products/Accessories

K-23723 Faucet cleaner

### Optional Products/Accessories

K-97703



### Codes/Standards







ASME A112.18.1/CSA B125.1  
DOE - Energy Policy Act 1992  
EPA WaterSense®  
California Energy Commission (CEC)

### KOHLER® Faucet Lifetime Limited Warranty

See website for detailed warranty information.

### Available Colors/Finishes

*Color tiles intended for reference only.*

Color	Code	Description
	CP	Polished Chrome
	BN	Vibrant® Brushed Nickel
	BL	Matte Black
	2MB	Vibrant® Brushed Moderne Brass
	CBL	Matte Black with Polished Chrome
	BMB	Matte Black with Moderne Brass

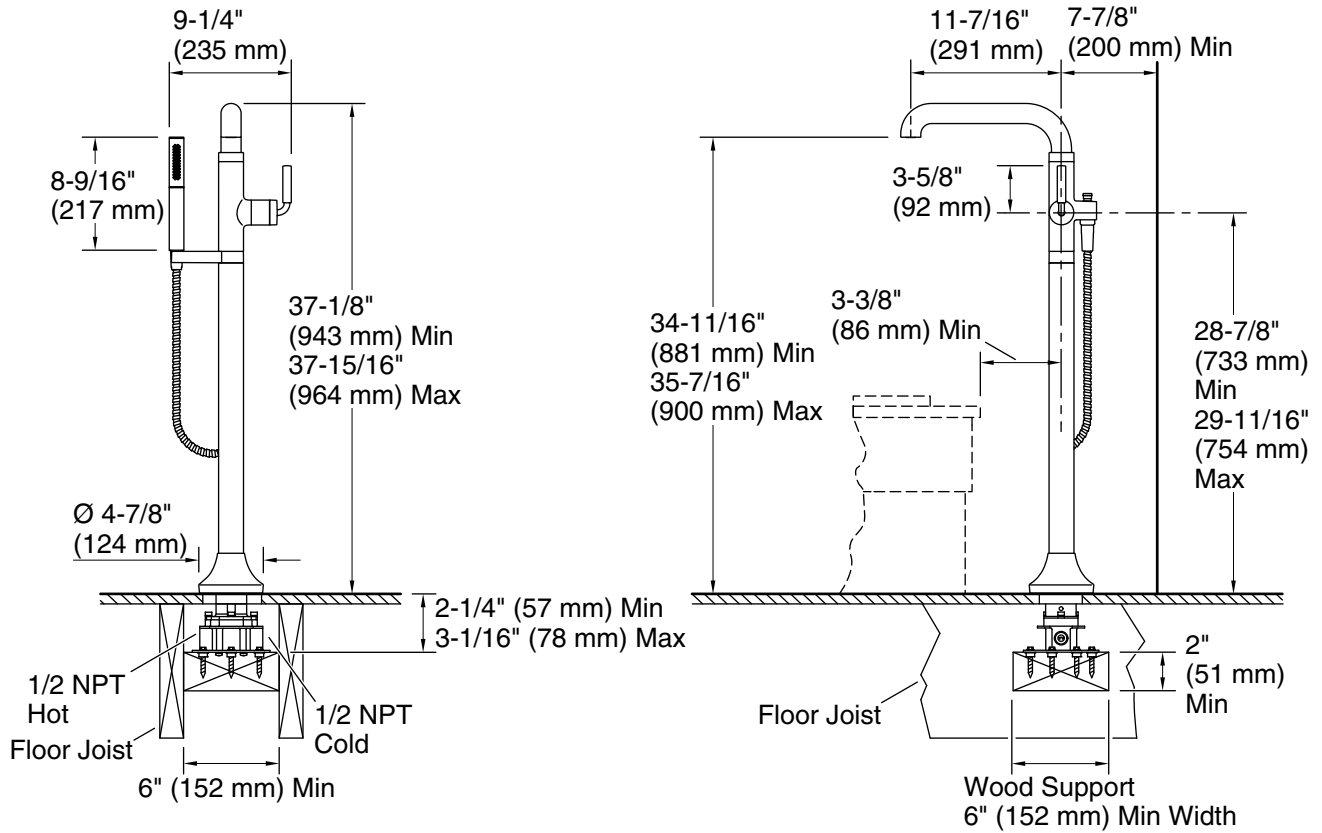

**Technical Information**

All product dimensions are nominal.

Drain included: No

**Notes**

Install this product according to the installation instructions.