

### Features

- A single handle controls both on/off activation and temperature setting
- Includes faceplate with ADA-compliant metal lever handle and push-button diverter
- Pressure-balancing diaphragm technology maintains outlet temperature within +/-3°F during water pressure fluctuations
- Antiscald protection
- Part of the Occasion bathroom faucet and accessory collection

### Material

- Premium material construction with metal handle ensures reliability and durability
- KOHLER finishes resist corrosion and tarnishing

### Installation

- Wall-mount
- Trim only; requires valve to complete installation (sold separately)

### Required Products/Accessories

K-11748 Series Rite-Temp® Valves

### Recommended Products/Accessories

K-23723 Faucet cleaner



**ADA** **CSA B651** **OBC**

### Codes/Standards







ASME A112.18.1/CSA B125.1  
ADA  
ICC/ANSI A117.1  
CSA B651  
OBC

### KOHLER® Faucet Lifetime Limited Warranty

See website for detailed warranty information.

### Available Colors/Finishes

*Color tiles intended for reference only.*

Color	Code	Description
	CP	Polished Chrome
	SN	Vibrant® Polished Nickel
	BN	Vibrant® Brushed Nickel
	BL	Matte Black
	2MB	Vibrant® Brushed Moderne Brass
	BMB	Matte Black with Moderne Brass

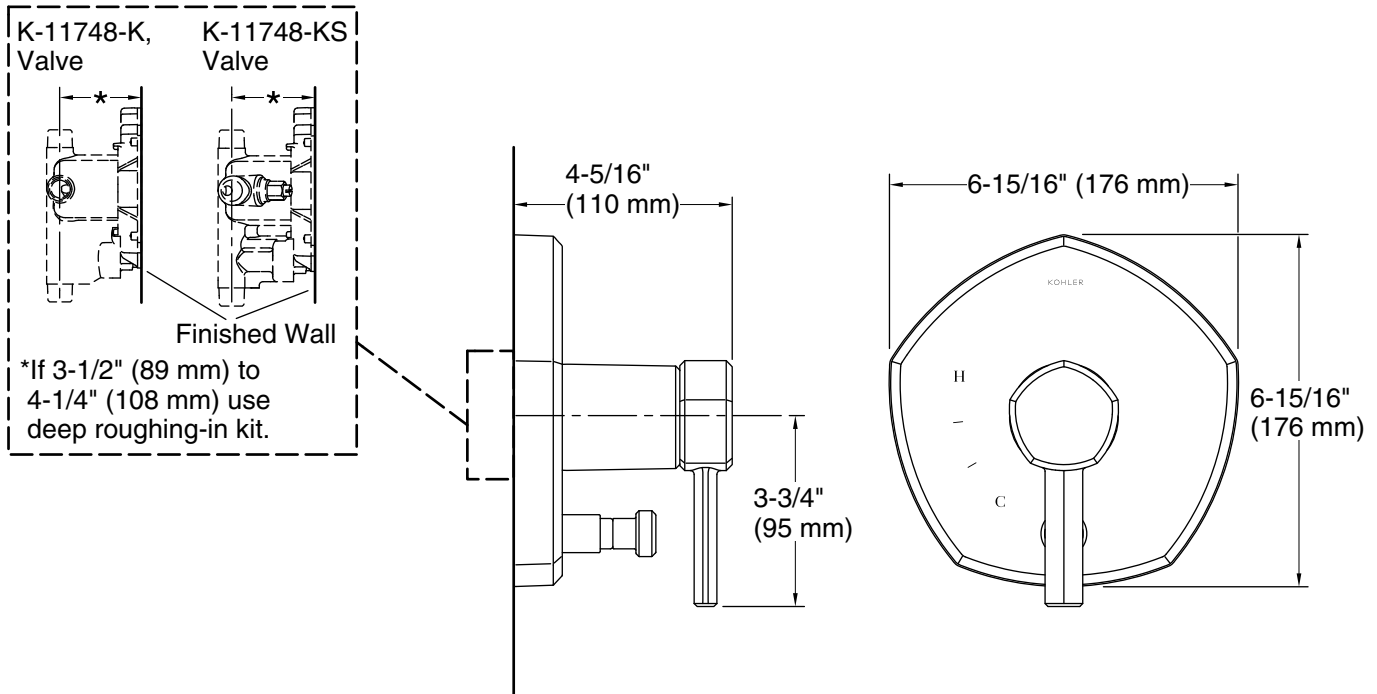

**Technical Information**

All product dimensions are nominal.

Drain included: No

**Notes**

ADA, OBC, CSA B651 compliant when installed to the specific requirements of these regulations.