

Features

- A single handle controls both on/off activation and temperature setting
- 9-1/8" (232 mm) high-arc spout
- 8.0 gpm (30.3 lpm) maximum bath faucet flow rate at 45 psi (3.1 bar)
- Includes Shift+™ Round 1.75 gpm handshower and 60" hose
- 1.75 gpm (6.6 lpm) maximum handshower flow rate at 80 psi (5.5 bar)
- KOHLER ceramic disc valves exceed industry longevity standards for a lifetime of durable performance
- Part of the Occasion bathroom faucet and accessory collection

Material

- Premium metal construction for durability and reliability
- KOHLER finishes resist corrosion and tarnishing

Installation

- Floor-mount

Included Components

Additional Components:
21335-G



Codes/Standards









ASME A112.18.1/CSA B125.1
DOE - Energy Policy Act 1992
EPA WaterSense™
California Energy Commission (CEC)

KOHLER® Faucet Lifetime Limited Warranty

See website for detailed warranty information.

Available Colors/Finishes

Color tiles intended for reference only.

Color	Code	Description
	CP	Polished Chrome
	SN	Vibrant™ Polished Nickel
	AF	Vibrant™ French Gold
	BN	Vibrant™ Brushed Nickel
	BV	Vibrant™ Brushed Bronze
	BL	Matte Black
	2MB	Vibrant™ Brushed Moderne Brass
	BMB	Matte Black with Moderne Brass

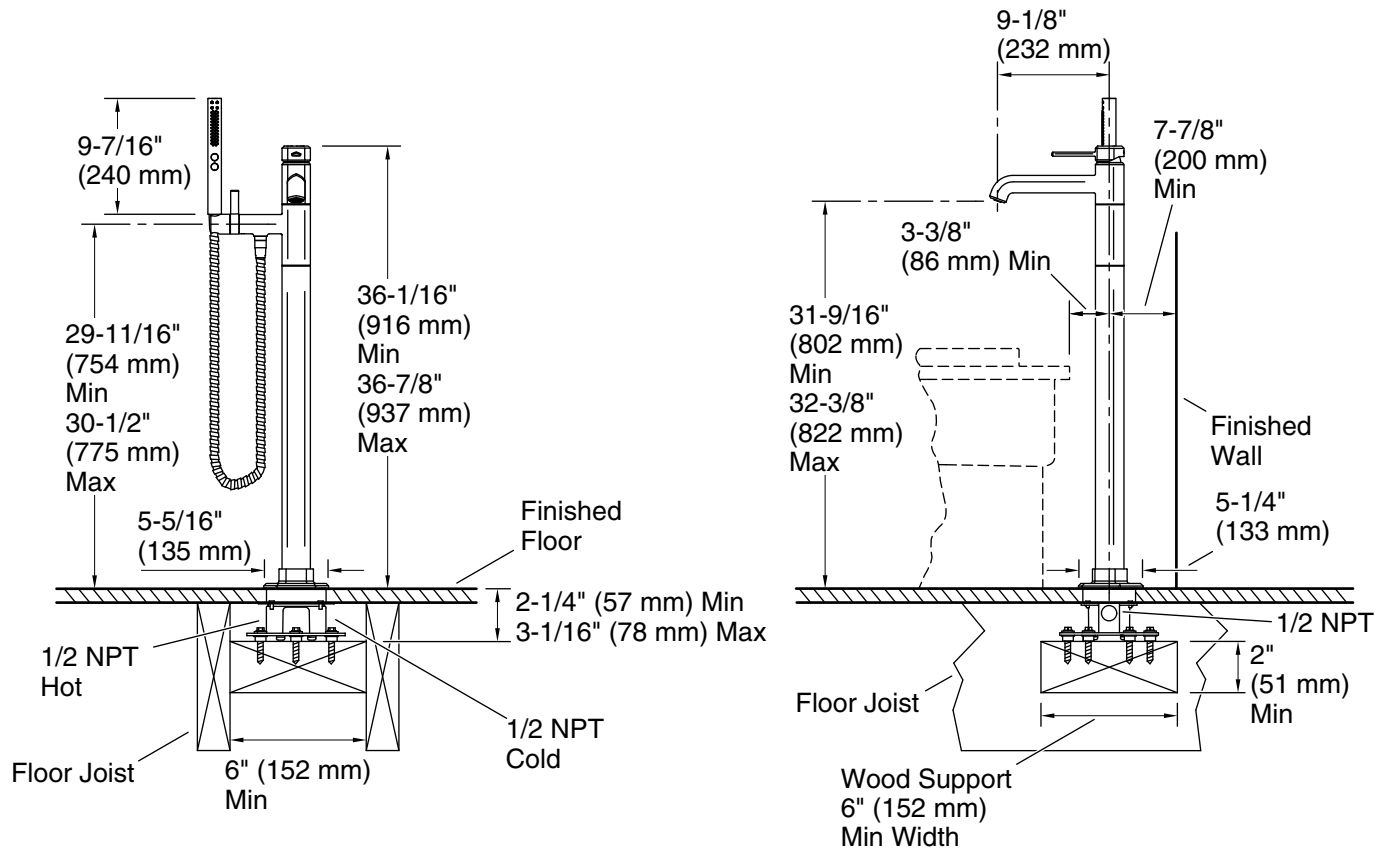

Technical Information

All product dimensions are nominal.

Shower Valve:

Pressure:	45 psi (3.1 bar)
Maximum (Static) Pressure:	125 psi (8.6 bar)
Minimum (Operating) Pressure:	20 psi (1.4 bar)
Drain included:	No