

Features

- 30" (762 mm) minimum base cabinet width
- Single bowl
- 9" (229 mm) depth provides generous workspace
- Five oversized faucet holes
- Bowl slopes toward drain to minimize water pooling
- Offset drain increases workspace in the sink and storage space underneath
- Box includes: Sink, sink rack, installation hardware, cutout template
- Sink drain with strainer sold separately

Material

- KOHLER® enameled cast iron
- Acid-resistant enamel finish

Installation

- Undermount

Recommended Products/Accessories

- K-8801 Sink drain and strainer with tailpiece
- K-8799 Sink drain and strainer basket
- K-23726 Drain treatment
- K-23725 Cast iron cleaner
- K-35000 Three-piece workstation sink accessory set
- K-35001 Maple wood cutting board
- K-35002 Ice bucket holder
- K-35003 Workstation sink cover
- K-35005 Marble serving tray
- K-35487 Three-piece ice bucket set
- K-35484 Three-piece workstation sink prep bowl set

Optional Products/Accessories

- K-11352 Disposal Flange with Stopper
- K-9000 P-Trap

Included Components

- K-9137 Sink Rack



Codes/Standards









ASME A112.19.1/CSA B45.2
IAPMO Certification

KOHLER® Enameled Cast Iron Kitchen and Bathroom Sink Lifetime Limited Warranty

See website for detailed warranty information.

Available Colors/Finishes

Color tiles intended for reference only.

Color	Code	Description
	0	White
	FF	Sea Salt™
	96	Biscuit
	NY	Dune
	95	Ice™ Grey
	58	Thunder™ Grey
	7	Black Black™
	TRF	Truffle

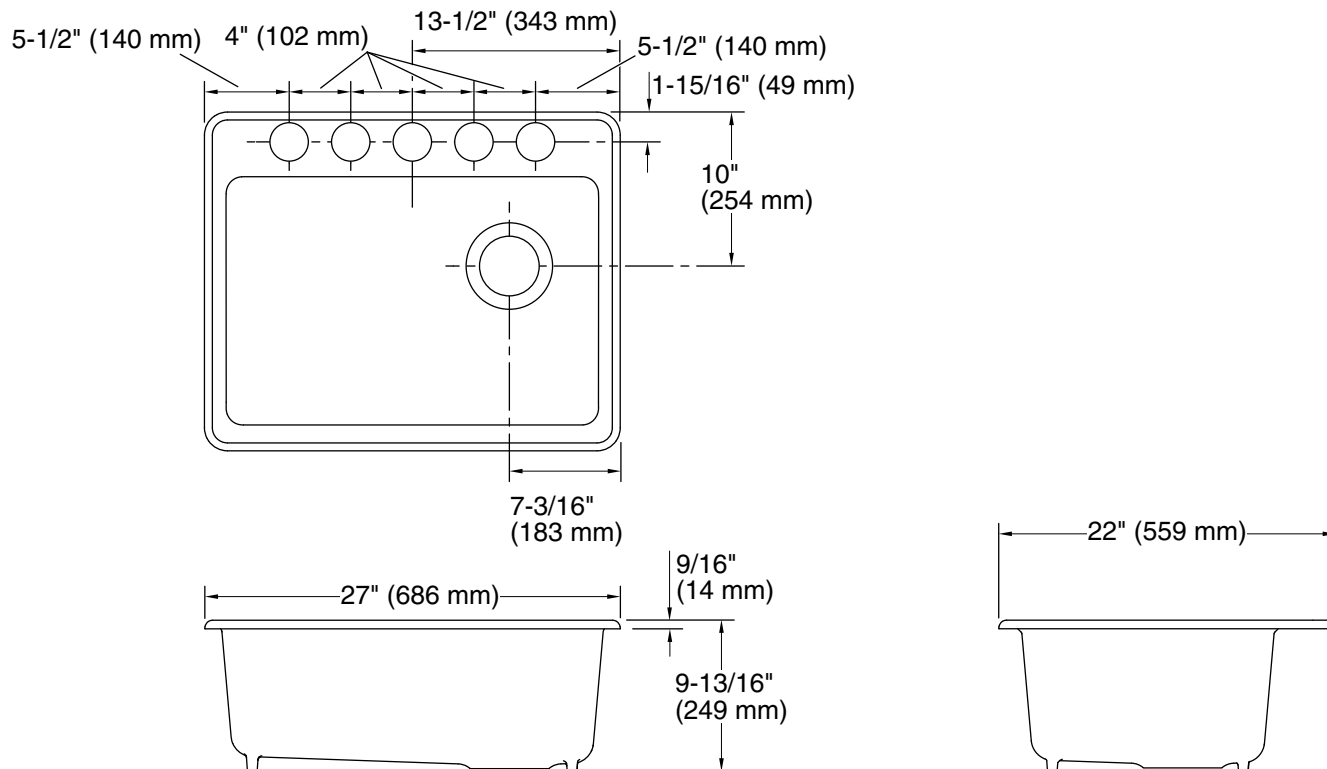

Technical Information

All product dimensions are nominal.

Basin configuration:	Single Bowl
Center(s):	8" (203 mm)
Min. base cabinet width:	30" (762 mm)
Bowl area (Basin #1):	Length: 24-1/4" (616 mm) Width: 15-13/16" (402 mm) Bowl depth: 9" (229 mm) Water depth: 9" (229 mm)
Number of deck holes:	5
Drain hole:	3-7/8" (98 mm)
Template:	Undermount, 1244382-7, required, included

Notes

Install this product according to the installation instructions.

NOTICE: Countertop manufacturer or cutter must use the cut-out template provided with the product, or a current one provided by Kohler Co. (call 1-800-4KOHLER). Kohler Co. is not responsible for cutout errors when the incorrect cut-out template is used.