



Tea-for-Two®

66" drop-in/undermount bath
K-855

Features

- Spacious design accommodates up to two bathers.
- Safeguard® slip-resistant surface on bath floor.
- End drain.

Material

- KOHLER® enameled cast iron.

Installation

- Undermount.
- Drop-in or undermount.

Required Products/Accessories

K-7147-AF 1-1/2" Contoured Pop-up Drain

Recommended Products/Accessories

K-587 Under-Mount Installation Kit
K-23726 Drain treatment
K-23725 Cast iron cleaner



Codes/Standards













ASME A112.19.1/CSA B45.2
ASTM F462

KOHLER® Enameled Cast Iron Bath and Shower Base Lifetime Limited Warranty

See website for detailed warranty information.

Available Colors/Finishes

Color tiles intended for reference only.

Color	Code	Description
	0	White
	96	Biscuit
	47	Almond
	NY	Dune
	95	Ice™ Grey
	G9	Sandbar
	33	Mexican Sand™
	K4	Cashmere
	58	Thunder™ Grey
	7	Black Black™
	GRL	Grey Lavender
	DGB	Indigo Blue
	PLM	Black Plum

1-800-4KOHLER (1-800-456-4537)

Kohler Co. reserves the right to make revisions without notice to product specifications.

For the most current Specification Sheet, go to www.kohler.com.

3-12-2020 13:04 - US/CA

THE BOLD LOOK
OF **KOHLER**®

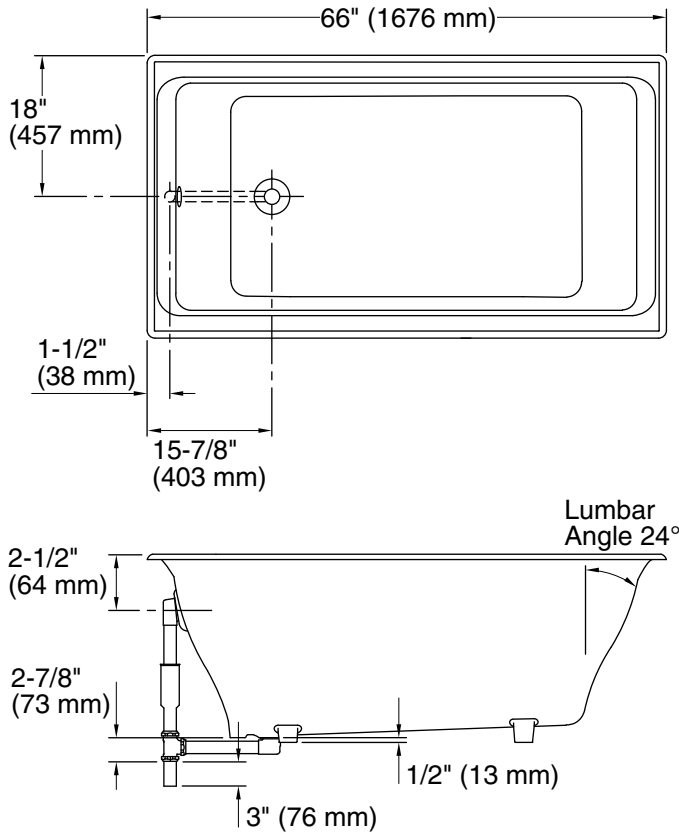

No change in measurements if connected with drain illustrated. (K-7147-AF)

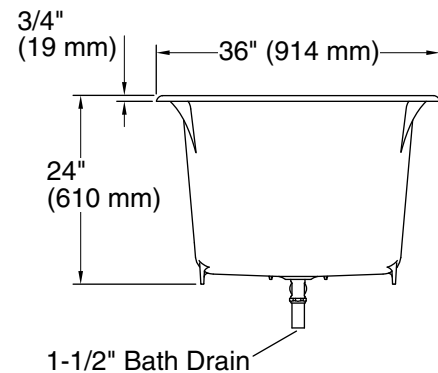

Technical Information

All product dimensions are nominal.

Installation:	Drop-in, Under-mount
Drain location:	End
Basin area, bottom:	45" x 25" (1143 mm x 635 mm)
Basin area, top:	58" x 29" (1473 mm x 737 mm)
Weight:	440 lbs (199.6 kg)
Minimum floor load:	81 lbs/ft ² (395.5 kg/m ²)
Water depth:	19-1/2" (495 mm)
Water capacity:	105 gal (397.5 L)
Cutout:	Drop-in, 64-1/2" x 34-1/2" (1638 mm x 876 mm)
Template:	Under-mount, K-587, required, not included
Minimum flat for door:	1-13/16" (46 mm)

Notes

Measure your actual product for rough-in details. Install this product according to the installation instructions.

The hot water supply should be 70% of the capacity of the bath or greater. Installations will vary.

Kit is required for under-mount installations (sold separately).