



**Whitehaven®**  
Smart Divide® 35-3/4" undermount double-bowl  
farmhouse kitchen sink  
**K-6427**

### Features

- Fits minimum 36" (914 mm) apron sink base cabinet
- Large/medium bowls
- 9" (229 mm) depth provides generous workspace
- Self-Trimming® apron overlaps cabinet face for easy installation and beautiful results
- Smart Divide® feature offers a lower bowl divider that increases workspace versatility
- Bowl slopes toward drain to minimize water pooling
- Offset drain increases workspace in the sink and storage space underneath

### Material

- KOHLER® enameled cast iron

### Installation

- Cutout templates included
- Undermount

### Required Products/Accessories

K-5828 Sink Rack

K-5874 Sink Rack

or

K-11352 Disposal Flange with Stopper

or

K-8801 Sink drain and strainer with tailpiece

or

K-8799 Sink drain and strainer basket

### Recommended Products/Accessories

K-23726 Drain treatment

K-23725 Cast iron cleaner

### Optional Products/Accessories

K-9000 P-Trap



### Codes/Standards









ASME A112.19.1/CSA B45.2

### KOHLER® Enameled Cast Iron Kitchen and Bathroom Sink Lifetime Limited Warranty

See website for detailed warranty information.

### Available Colors/Finishes

*Color tiles intended for reference only.*

Color	Code	Description
	0	White
	FF	Sea Salt™
	96	Biscuit
	NY	Dune
	95	Ice™ Grey
	58	Thunder™ Grey
	7	Black Black™
	TRF	Truffle

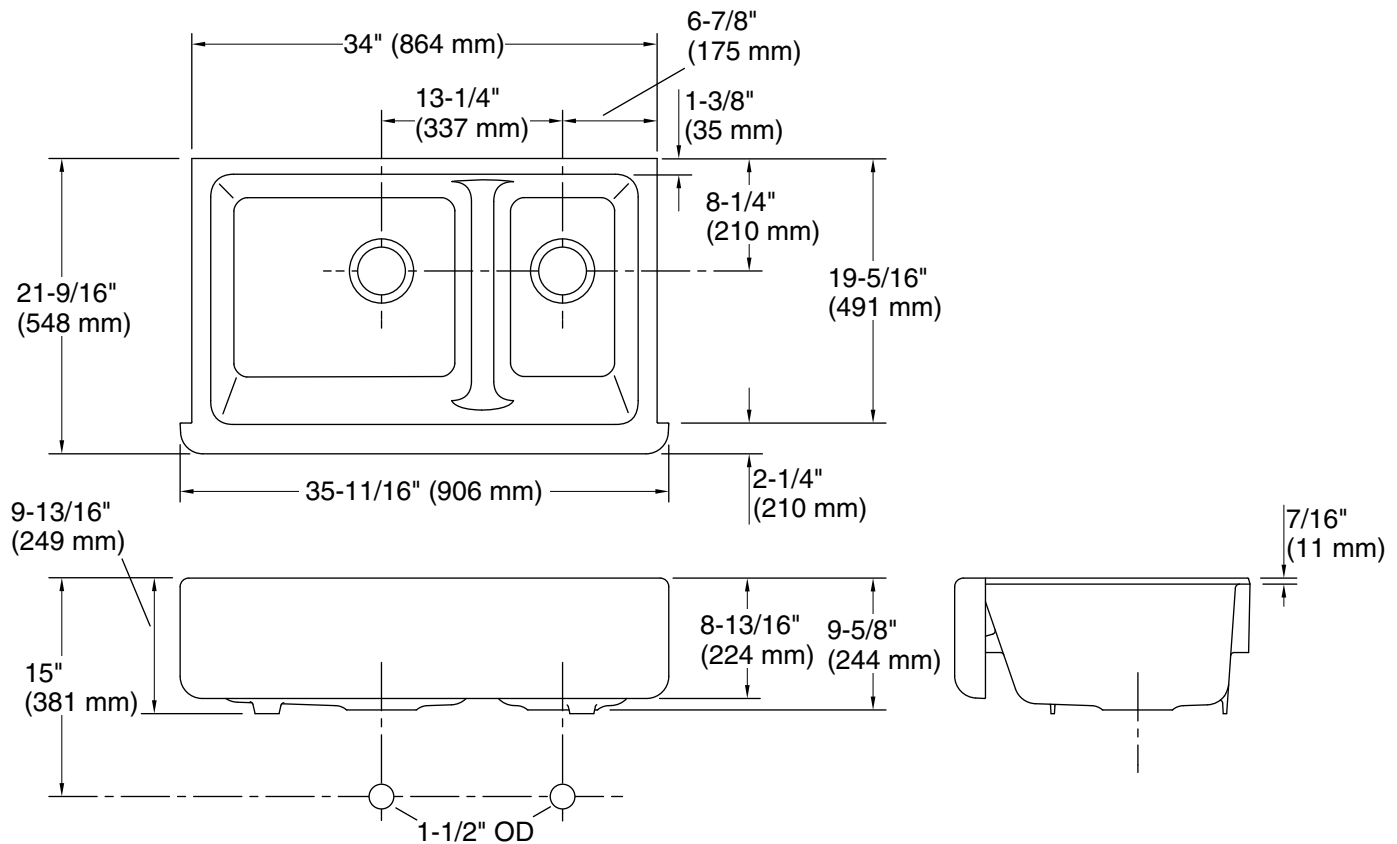

## Technical Information

All product dimensions are nominal.

Bowl configuration: Off-set Large/small

Min. base cabinet width: 36" (914 mm)

Bowl area (Left): Length: 18-13/16" (478 mm)  
Width: 18-1/16" (459 mm)  
Bowl depth: 9" (229 mm)

Bowl area (Right): Length: 10-5/16" (262 mm)  
Width: 18-1/16" (459 mm)  
Bowl depth: 9" (229 mm)  
Water depth: 9" (229 mm)

Drain hole: 3-5/8" (92 mm)

## Notes

Install this product according to the installation instructions.

**NOTICE:** The countertop manufacturer or cutter must use the cut-out template provided with the product, or a current one provided by Kohler Co. (call 1-800-4KOHLER). Kohler Co. is not responsible for cut-out errors when the incorrect cut-out template is used.

**IMPORTANT!** The distance from the top edge of the cabinet to the top of the cabinet door must be at least 9" (229 mm) to install this sink.