



# Whitehaven® 32-3/4" undermount single-bowl farmhouse kitchen sink K-5827

## Features

- Fits minimum 33" (838 mm) apron sink base cabinet
- Single bowl
- 9" (229 mm) depth provides generous workspace
- Self-Trimming® apron overlaps cabinet face for easy installation and beautiful results
- Bowl slopes toward drain to minimize water pooling
- Offset drain increases workspace in the sink and storage space underneath

## Material

- KOHLER® enameled cast iron

## Installation

- Cutout templates included
- Undermount

## Required Products/Accessories

For under-mount installation

- K-11352 Disposal Flange with Stopper
- K-6449 Stainless steel sink racks
- K-8799 Sink drain and strainer basket
- K-8801 Sink drain and strainer with tailpiece

## Recommended Products/Accessories

- K-23726 Drain treatment
- K-23725 Cast iron cleaner

## Optional Products/Accessories

- K-9000 P-Trap



## Codes/Standards







ASME A112.19.1/CSA B45.2

## KOHLER® Enameled Cast Iron Kitchen and Bathroom Sink Lifetime Limited Warranty

See website for detailed warranty information.

## Available Colors/Finishes

*Color tiles intended for reference only.*

Color	Code	Description
	0	White
	FF	Sea Salt™
	96	Biscuit
	NY	Dune
	95	Ice™ Grey
	58	Thunder™ Grey
	7	Black Black™
	TRF	Truffle

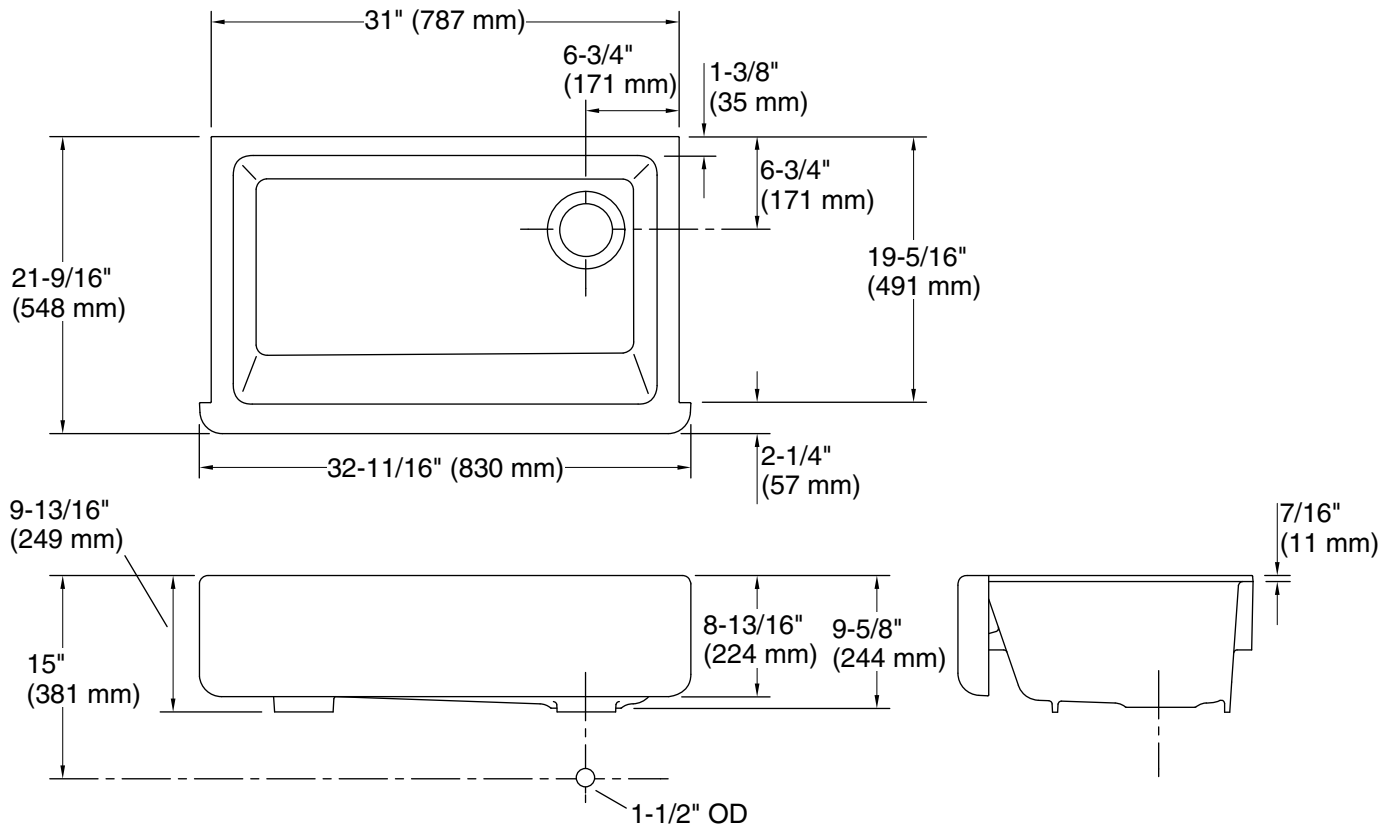

### Technical Information

All product dimensions are nominal.

Bowl configuration:	Single
Min. base cabinet width:	33" (838 mm)
Bowl area:	Length: 27-3/4" (705 mm) Width: 18-1/16" (459 mm) Bowl depth: 8-13/16" (224 mm) Water depth: 9" (229 mm)
Drain hole:	3-5/8" (92 mm)
Template:	1214395-7, required, included 1217812, required, included

### Notes

Install this product according to the installation instructions.

**NOTICE:** Countertop manufacturer or cutter must use the current product template available at [www.kohler.com](http://www.kohler.com), or by calling 1-800-4KOHLER. Kohler Co. is not responsible for cutout errors when the incorrect cutout template is used.

**IMPORTANT!** The distance from the top edge of the cabinet to the top of the cabinet door must be at least 9" (229 mm) to install this sink.