

Features

- Fits minimum 36" (914 mm) apron sink base cabinet
- Single bowl
- 9" (229 mm) depth provides generous workspace
- Self-Trimming® apron overlaps cabinet face for easy installation and beautiful results
- Bowl slopes toward drain to minimize water pooling
- Offset drain increases workspace in the sink and storage space underneath
- Sink drain and strainer sold separately

Material

- KOHLER® enameled cast iron
- Acid-resistant enamel finish

Installation

- Undermount
- For 36" (914 mm) apron-front cabinetry

Required Products/Accessories

K-8801 Sink drain and strainer with tailpiece

or

K-8799 Sink drain and strainer basket

or

K-11352 Disposal Flange with Stopper

K-6237 Left-Bowl Sink Rack

K-6255 Right-Bowl Sink Rack

Recommended Products/Accessories

K-23726 Drain treatment

K-23725 Cast iron cleaner

K-6239 Colander with Cutting Board

Optional Products/Accessories

K-9000 P-Trap

Included Components

K-6194 Utility Rack With Soaking Cup

K-6246 Maple hardwood cutting board



Codes/Standards

ASME A112.19.1/CSA B45.2









IAPMO Certification

KOHLER® Enameled Cast Iron Kitchen and Bathroom Sink Lifetime Limited Warranty

See website for detailed warranty information.

Available Colors/Finishes

Color tiles intended for reference only.

Color	Code	Description
	0	White
	FF	Sea Salt™
	96	Biscuit
	NY	Dune
	95	Ice™ Grey
	58	Thunder™ Grey
	7	Black Black™
	TRF	Truffle

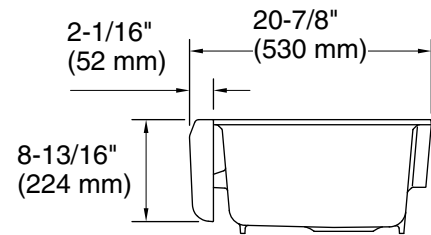
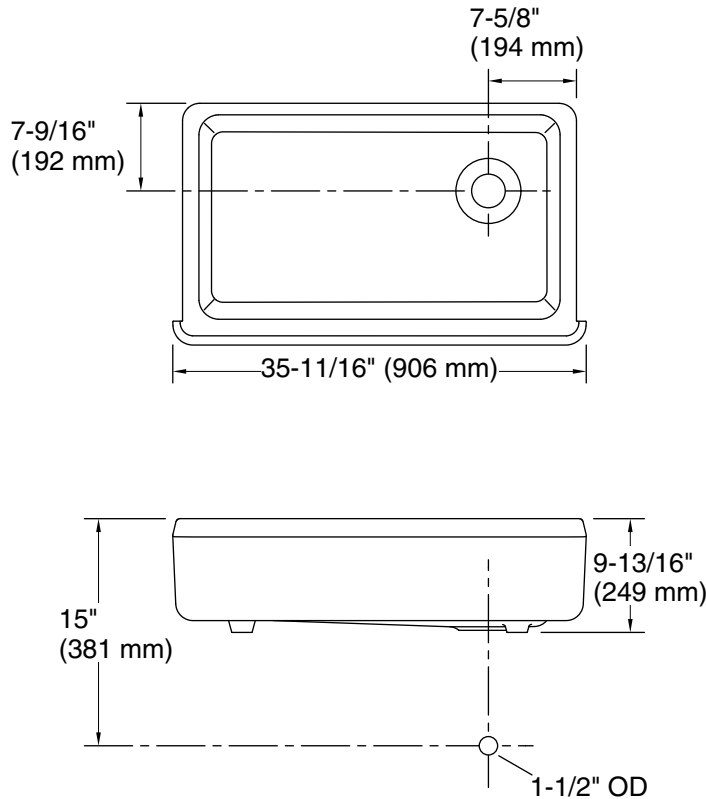

Technical Information

All product dimensions are nominal.

Bowl configuration: Single

Min. base cabinet width: 36" (914 mm)

Bowl area (Only):
 Length: 30-1/4" (769 mm)
 Width: 15-13/16" (402 mm)
 Bowl depth: 9" (229 mm)
 Water depth: 9" (229 mm)

Drain hole: 3-7/8" (98 mm)

Template: Undermount, 1398641-7, required, included
 Apron-front, 1157001, required, included

Notes

Install this product according to the installation instructions.

Install this product according to the installation instructions.