

Replacement Parts

Geberit Type 50, Type 30, Type 10, Bolero and Mambo Urinal Actuators

116.015 116.017 116.016 116.012 116.013 Actuator Dimensions: 5.12" x 5.12" (13 cm x 13 cm)

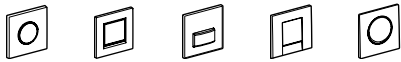

Item	Model No.	Description	List Price
1	241.915.SN.1	Actuator plate Type 10/Mambo, Brushed SS	\$189.00
1	243.270.KH.1	Actuator plate Type 30, Polished Chrome-Matte Chrome-Polished Chrome	75.00
1	243.270.KJ.1	Actuator plate Type 30, White-Polished Chrome-White	75.00
1	242.764.11.1	Actuator plate Type 50, Alpine White	189.00
1	242.764.GH.1	Actuator plate Type 50, Brushed Chrome	376.00
1	242.764.SQ.1	Actuator plate Type 50, Umber Glass	189.00
1	242.764.00.1	Actuator plate Type 50, Custom	189.00
2	241.934.00.1	Stop valve with throttle, complete	63.00
2.1	241.933.00.1	Regulating screw	21.00
3	241.937.00.1	Pneumatic actuator with mounting frame	63.00
4	241.931.00.1	Distance bolts, set	3.00
5	241.935.00.1	Pneumatic valve	138.00
5.1	241.932.00.1	Basket filter	3.00
5.2	241.936.00.1	Nozzle set, White	16.00
6	241.947.00.1	Insulation protection with connection terminal	5.00
7	242.156.00.1	Lip seal flushing pipe	3.00
8	242.484.00.1	Flow limiter for UR-controls	6.00

116.015

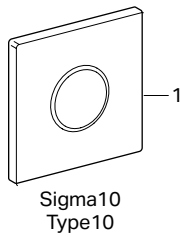

116.017

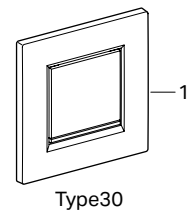

116.016

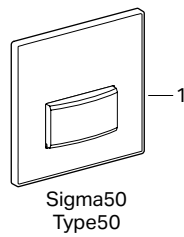

116.012

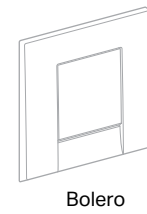

116.013

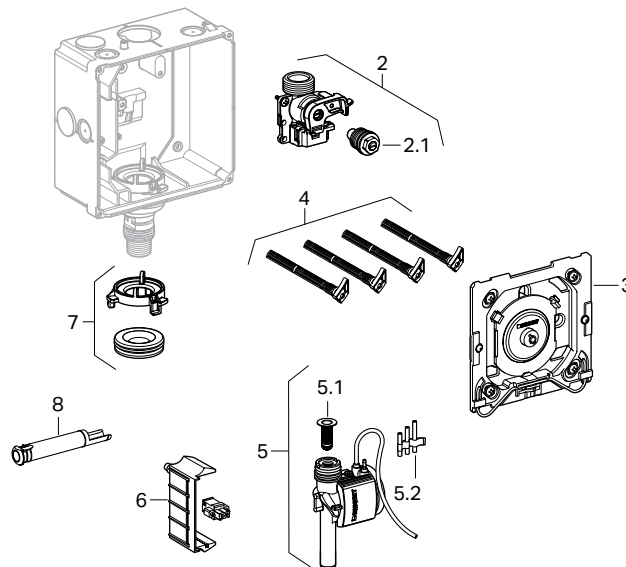
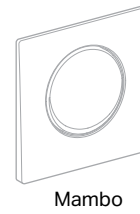

Products marked with  comply with the American Disabilities Act (ADA) when installed per the requirements of the latest ADA Accessibility Guidelines (ADAAG) and/or ICC/ANSI A117.1.