

GENERATION LIGHTING

**UNDERCABINET**

**GENERAL PRODUCT INFORMATION:**

This product is safety listed for damp locations.

This product may be dimmed with a low-voltage electronic dimmer.

This instruction shows a typical installation.

**CAUTION - RISK OF FIRE**  
 This product must be installed in accordance with the applicable installation code by a person familiar with the construction and operation of the product and the hazards involved.  
 Use minimum 90°C supply conductors.

**Install the Fixture**

**Note:** Multiple fixtures may be interconnected at any distance apart in accordance with NEC specifications.

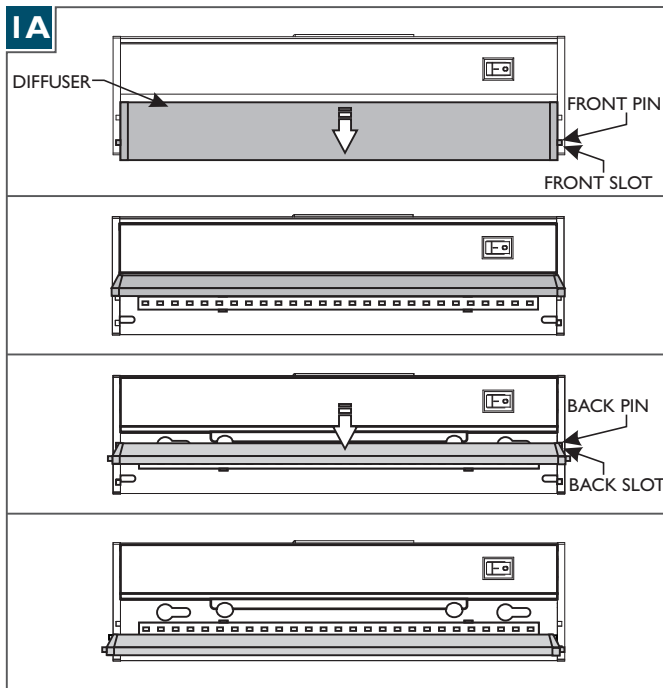

- 1** Slide the diffuser completely forward so that the front pins are aligned with the front slots on the fixture.
- 2** Rotate the diffuser up to open the fixture.
- 3** Slide the diffuser forward so that the back pins are aligned with the back slots on the fixture.
- 4** Remove the diffuser.

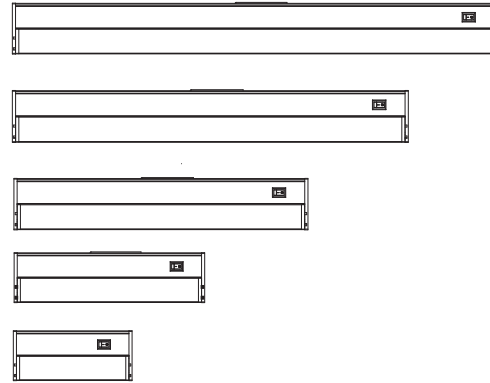

GENERATION LIGHTING

7400 Linder Ave, Skokie, IL 160077  
 800.969.3347

[www.generationlighting.com](http://www.generationlighting.com)

© 2019 Generation Lighting. All rights reserved.  
 The "Generation Lighting" graphic is a registered trademark of Generation Lighting. Generation Lighting reserves the right to change specifications for product improvements without notification.

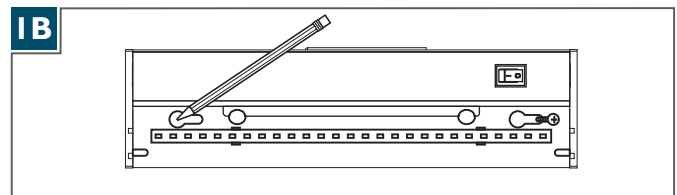

- 5** Use the keyhole slots to install the fixture(s).
- 6** If using a plug-in wall feed, replace the diffuser (reversal of section 1A) and skip to section 3.

**Hard Wire the Fixture**

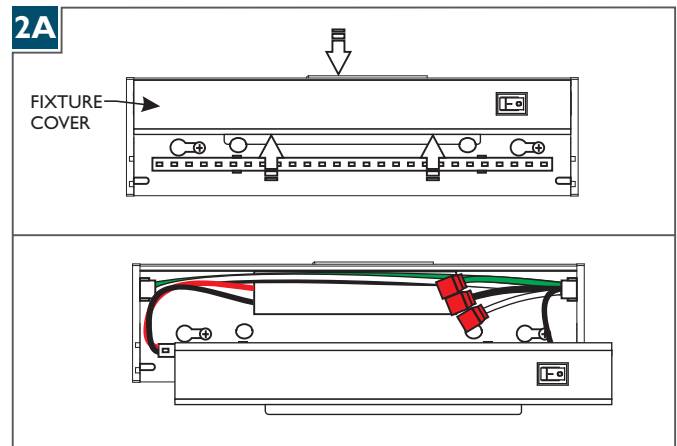

- 1** Remove the fixture cover by squeezing the inside of the cover to release it.

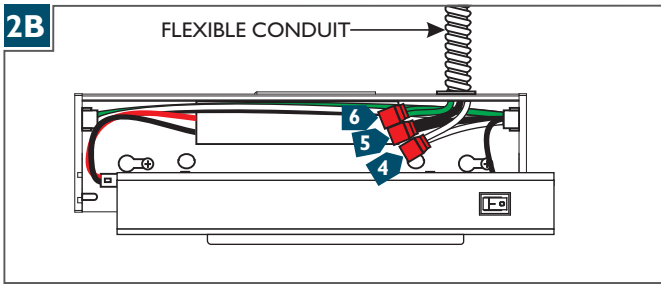

- 2** Determine the desired location of the conduit connection and remove one of the knockout from the back of the fixture.
- 3** Install the conduit adapter to the determined knockout location and feed the flexible conduit and the power lines into the fixture. Secure it by tightening down the screw on the conduit adapter.
- 4** Push the neutral power line to the wire connector with the pre-installed white wire.
- 5** Push the hot power line to the wire connector with the pre-installed black wire.
- 6** Connect the fixture to a suitable ground in accordance with local electrical code.
- 7** Properly place the wires and wire connectors into the top half of the fixture, replace the fixture cover (reversal of section 2A).
- 8** Replace the diffuser (reversal of section 1A).

### Plug-In Wall Feed

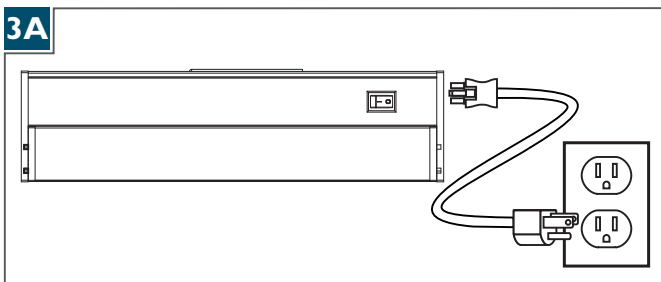

- 1** Using the Plug-In Wall Feed, plug the Undercabinet unit directly into a wall outlet.

### Jumper Connector

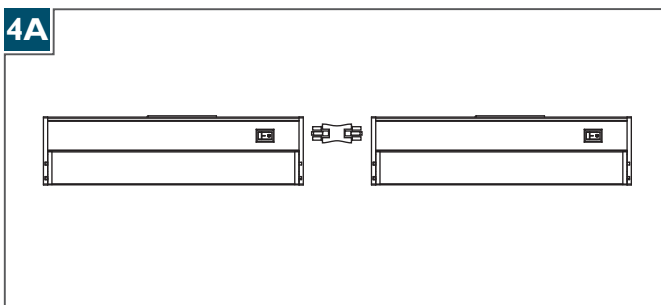

- 1** Remove the connector cover and use the Jumper Connectors to link multiple Undercabinet units to one another.

**SAVE THESE INSTRUCTIONS!**