

PRODUCT SPECIFICATIONS

Elkay Lustertone® Classic Stainless Steel 22" x 17" x 7-5/8" 2-Hole Single Drop-in Classroom Sink + Faucet/Bubbler Kit and Vandal-resistant Filtration Kit With Filter Status Monitor. Sink is manufactured from 18 gauge 304 Stainless Steel with a Lustrous Satin finish, Center drain placement, and Bottom only pads.



| | |
|------------------------------|----------------------------|
| Installation Type: | Drop-in, Sink Kits |
| Material: | 304 Stainless Steel |
| Finish: | Lustrous Satin |
| Gauge: | 18 |
| Sound Deadening: | Bottom only pads |
| Number of Bowls: | 1 |
| Sink Dimensions: | 22" x 17" x 7-5/8" |
| Bowl 1 Dimensions: | 16" x 13-1/2" x 7-1/2" |
| Drain Size: | 3-1/2" (89mm) |
| Drain Location: | Center |
| Minimum Cabinet Size: | 27" |
| Cutout Template #: | 1000001261 |

Template is available for download at [elkay.com](#). CAD software will be required to open the template.

Cutout Dimensions for Drop-in Installation:

21-3/8" x 16-3/8" (543mm x 416mm) with 1-1/2" (38mm) corner radius

Installation Profile:

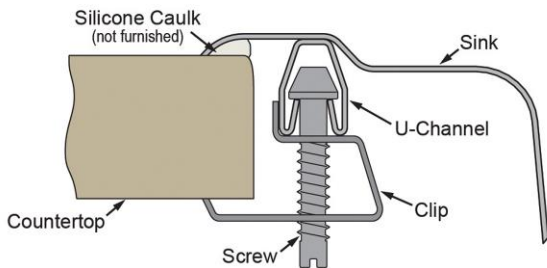

Included with Product: DRKR2217 sink, LKDVR208513LC faucet, LKVR1141A bubbler, LKVR18 strainer, EF3000VRBMC filtration kit

▼ Ships in multiple boxes.

A Century of Tradition and Quality.

For more than 100 years, Elkay has been making innovative products and providing exceptional customer care. We take pride in offering plumbing products that make life easier, inspire change and leave the world a better place.



Product Compliance: ASME A112.19.3/CSA B45.4
Faucet: ASME A112.18.1/CSA B125.1
 NSF 61 (Q≤1)
 NSF 372 (lead free)
 CEC
Accessory: NSF 42
 NSF 53
 ASME A112.18.2/CSA B125.2
 NSF 401

- [Clean and Care Manual \(PDF\)](#)
- [Installation Instructions \(PDF\) - 1000005236](#)
- [Installation Instructions \(PDF\) - A55068 Bubbler](#)
- [Installation Instructions \(PDF\) - 1000005235 drain](#)
- [Installation Instructions \(PDF\) - 2000001249](#)
- [Warranty \(PDF\)](#)

PART: _____ QTY: _____

PROJECT: _____





CONTACT: _____

DATE: _____

NOTES: _____

APPROVAL: _____

In keeping with our policy of continuing product improvement, Elkay reserves the right to change product specifications without notice. Please visit [elkay.com](#) for the most current version of Elkay product specification sheets. This specification describes an Elkay product with design, quality, and functional benefits to the user. When making a comparison of other producers' offerings, be certain these features are not overlooked.

| Included Accessories | | |
|-----------------------------|--|---|
| LKD208513C | Elkay Single Hole 12-1/2" Deck Mount Faucet with Gooseneck Spout Lever Handle on Right Side Chrome Spec Sheet (PDF) |  |
| LK1141A | Elkay Flexi-Guard® Safety Bubbler Classroom Bubbler Spec Sheet (PDF) |  |
| LK35 | 3-1/2" Drain Fitting Type 304 Stainless Steel Body Strainer Basket and Tailpiece Spec Sheet (PDF) |  |
| EF3000VRBMC | Elkay Universal Vandal-Resistant 3000 Gal. Filtration Kit with Filter Status Monitor Spec Sheet (PDF) |  |

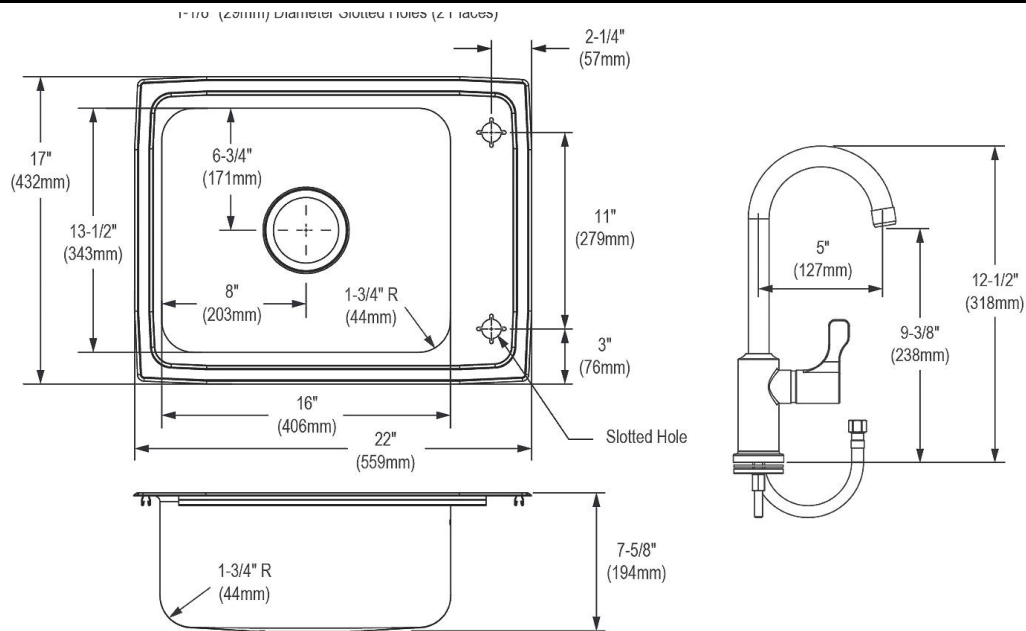

In keeping with our policy of continuing product improvement, Elkay reserves the right to change product specifications without notice. Please visit elkay.com for the most current version of Elkay product specification sheets. This specification describes an Elkay product with design, quality, and functional benefits to the user. When making a comparison of other producers' offerings, be certain these features are not overlooked.

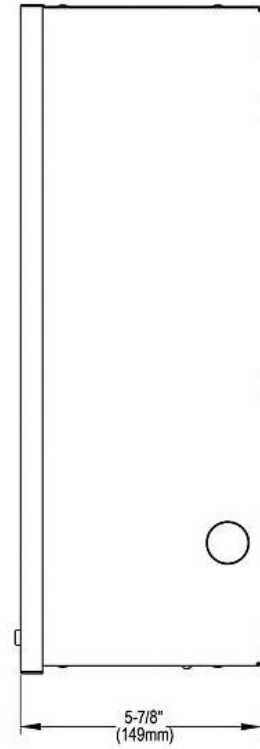
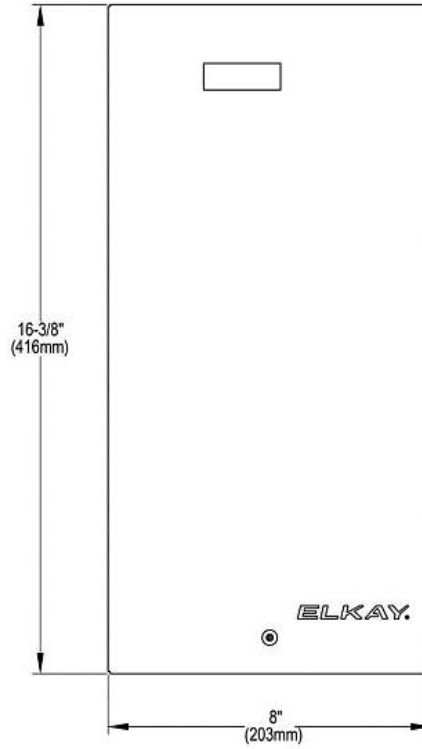

In keeping with our policy of continuing product improvement, Elkay reserves the right to change product specifications without notice. Please visit elkay.com for the most current version of Elkay product specification sheets. This specification describes an Elkay product with design, quality, and functional benefits to the user. When making a comparison of other producers' offerings, be certain these features are not overlooked.