

PRODUCT SPECIFICATIONS

Elkay Lustertone® Classic Stainless Steel 37-1/4" x 17" x 4" Double Bowl Drop-in Classroom ADA Sink Kit and Vandal-resistant Filtration Kit With Filter Status Monitor. Sink is manufactured from 18 gauge 304 Stainless Steel with a Lustrous Satin finish, Center drain placement, and Bottom only pads.

Installation Type:	Drop-in, Sink Kits
Material:	304 Stainless Steel
Finish:	Lustrous Satin
Gauge:	18
Sound Deadening:	Bottom only pads
Number of Bowls:	2
Sink Dimensions:	37-1/4" x 17" x 4"
Bowl 1 Dimensions:	9-1/4" x 12" x 3-1/2"
Bowl 2 Dimensions:	16" x 11-1/2" x 3-7/8"
Drain Size:	2" (51mm), 3-1/2" (89mm)
Drain Location:	Center
Minimum Cabinet Size:	42"
Cutout Template #:	1000000735

Template is available for download at [elkay.com](#). CAD software will be required to open the template.

Cutout Dimensions for Drop-in Installation:

36-5/8" x 16-3/8" (930mm x 416mm) with 1-1/2" (38mm) corner radius

Installation Profile:

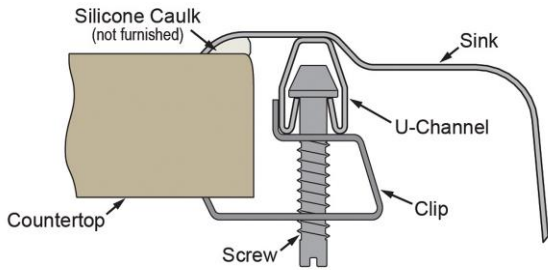

Included with Product: DRKAD371740L4 sink, LKD2439C faucet, LK1141A bubbler, LK35 strainer, LK8 drain fitting, EF3000VRBMC filtration kit

Ships in multiple boxes.

A Century of Tradition and Quality.

For more than 100 years, Elkay has been making innovative products and providing exceptional customer care. We take pride in offering plumbing products that make life easier, inspire change and leave the world a better place.



Product Compliance:

- ADA & ICC A117.1
- ASME A112.19.3/CSA B45.4
- Faucet: ASME A112.18.1/CSA B125.1
- NSF 61 (Q≤1)
- NSF 372 (lead free)
- CEC
- Accessory: NSF 42
- NSF 53
- ASME A112.18.2/CSA B125.2
- NSF 401



Complies with ADA & ICC A117.1 accessibility requirements when installed according to the requirements outlined in these standards.

- [Clean and Care Manual \(PDF\)](#)
- [Installation Instructions \(PDF\) - 1000005236](#)
- [Installation Instructions \(PDF\) - 0000000998](#)
- [Installation Instructions \(PDF\) - A55068 Bubbler](#)
- [Installation Instructions \(PDF\) - 1000005235 drain](#)
- [Installation Instructions \(PDF\) - 2000001249](#)
- [Warranty \(PDF\)](#)

PART: _____ QTY: _____

PROJECT: _____





CONTACT: _____

DATE: _____

NOTES: _____

APPROVAL: _____

In keeping with our policy of continuing product improvement, Elkay reserves the right to change product specifications without notice. Please visit [elkay.com](#) for the most current version of Elkay product specification sheets. This specification describes an Elkay product with design, quality, and functional benefits to the user. When making a comparison of other producers' offerings, be certain these features are not overlooked.

Included Accessories		
LLKD2439C	Spec Sheet (PDF)	
LK1141A	Elkay Flexi-Guard® Safety Bubbler Classroom Bubbler Spec Sheet (PDF)	
LK35	3-1/2" Drain Fitting Type 304 Stainless Steel Body Strainer Basket and Tailpiece Spec Sheet (PDF)	
LK8	2" Drain Fitting Type 304 Stainless Steel Body Grid Strainer and Tailpiece Spec Sheet (PDF)	
EF3000VRBMC	Elkay Universal Vandal-Resistant 3000 Gal. Filtration Kit with Filter Status Monitor Spec Sheet (PDF)	

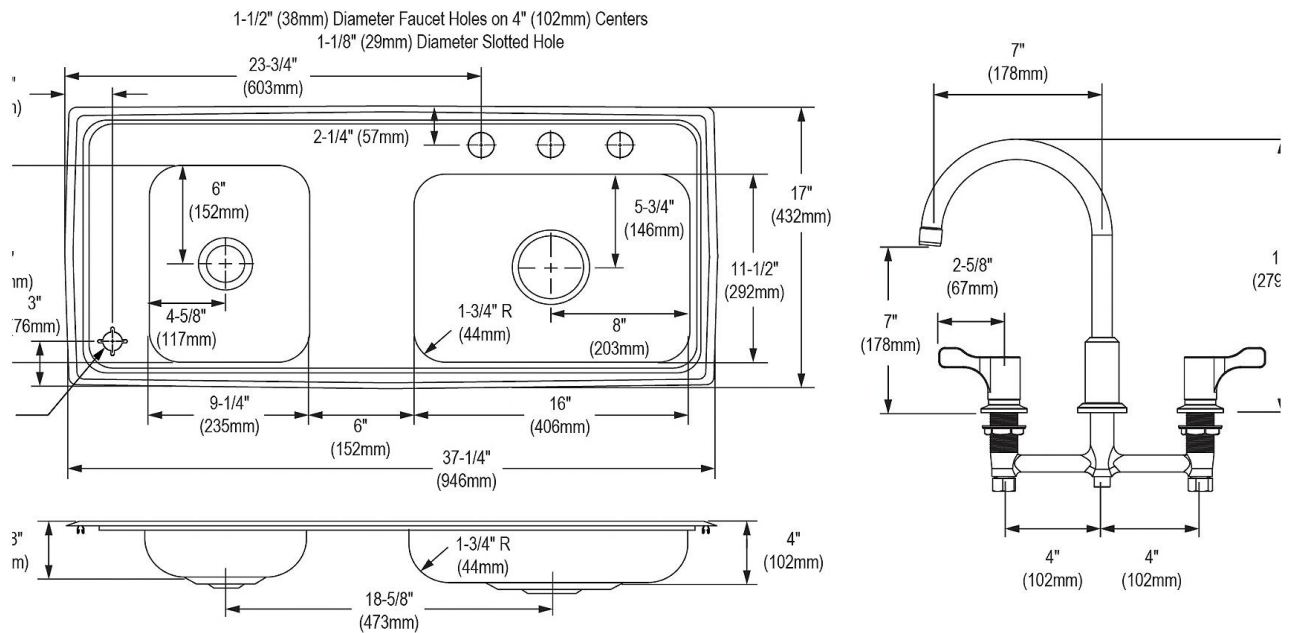

In keeping with our policy of continuing product improvement, Elkay reserves the right to change product specifications without notice. Please visit elkay.com for the most current version of Elkay product specification sheets. This specification describes an Elkay product with design, quality, and functional benefits to the user. When making a comparison of other producers' offerings, be certain these features are not overlooked.

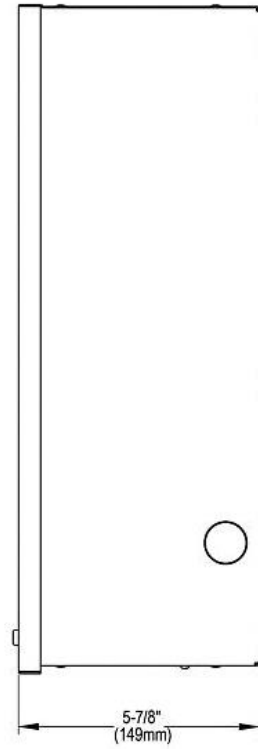
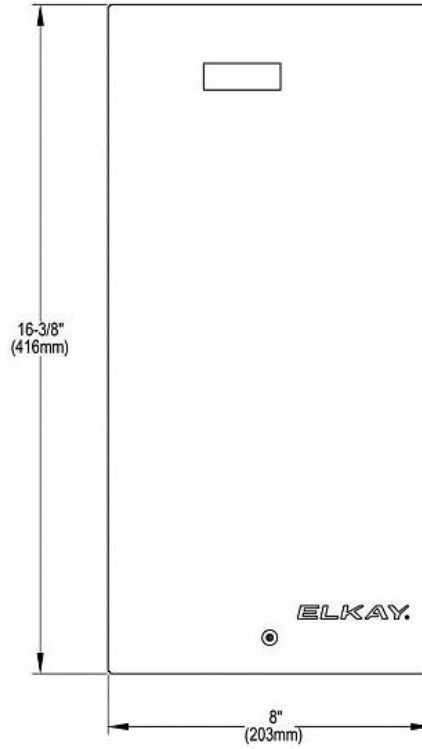

In keeping with our policy of continuing product improvement, Elkay reserves the right to change product specifications without notice. Please visit elkay.com for the most current version of Elkay product specification sheets. This specification describes an Elkay product with design, quality, and functional benefits to the user. When making a comparison of other producers' offerings, be certain these features are not overlooked.