

**PRODUCT SPECIFICATIONS**

Elkay Lustertone® Classic Stainless Steel 28" x 22" x 4-1/2" Single Bowl Drop-in Classroom ADA Sink Kit and Vandal-resistant Filtration Kit With Filter Status Monitor. Sink is manufactured from 18 gauge 304 Stainless Steel with a Lustrous Satin finish, Rear Center drain placement, and Bottom only pads.

<b>Installation Type:</b>	Drop-in, Sink Kits
<b>Material:</b>	304 Stainless Steel
<b>Finish:</b>	Lustrous Satin
<b>Gauge:</b>	18
<b>Sound Deadening:</b>	Bottom only pads
<b>Number of Bowls:</b>	1
<b>Sink Dimensions:</b>	28" x 22" x 4-1/2"
<b>Bowl 1 Dimensions:</b>	19" x 16" x 4-3/8"
<b>Drain Size:</b>	3-1/2" (89mm)
<b>Drain Location:</b>	Rear Center
<b>Minimum Cabinet Size:</b>	33"
<b>Cutout Template #:</b>	<a href="#">1000001277</a>

Template is available for download at [elkay.com](#). CAD software will be required to open the template.

**Cutout Dimensions for Drop-in Installation:**

27-3/8" x 21-3/8" (695mm x 543mm) with 1-1/2" (38mm) corner radius

**Installation Profile:**

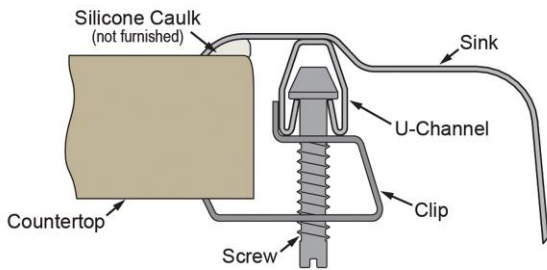

**Included with Product:** DRKAD282245L sink, LKF413945RS faucet, LK1141A bubbler, LKAD35 strainer, EF3000VRBMC filtration kit

**▼ Ships in multiple boxes.**

A Century of Tradition and Quality.

For more than 100 years, Elkay has been making innovative products and providing exceptional customer care. We take pride in offering plumbing products that make life easier, inspire change and leave the world a better place.



**Product Compliance:**

ADA & ICC A117.1

ASME A112.19.3/CSA B45.4

**Faucet:**

ASME A112.18.1/CSA B125.1

NSF 61 (Q≤1)

NSF 372 (lead free)

CEC

**Accessory:**

NSF 42

NSF 53

ASME A112.18.2/CSA B125.2

NSF 401



Complies with ADA & ICC A117.1 accessibility requirements when installed according to the requirements outlined in these standards.

[Clean and Care Manual \(PDF\)](#)

[Installation Instructions \(PDF\) - 1000005236](#)

[Installation Instructions \(PDF\) - 0000000474](#)

[Installation Instructions \(PDF\) - A55068\\_Bubbler](#)

[Installation Instructions \(PDF\) - 1000005235\\_drain](#)

[Installation Instructions \(PDF\) - 2000001249](#)

[Warranty \(PDF\)](#)

PART: \_\_\_\_\_ QTY: \_\_\_\_\_

PROJECT: \_\_\_\_\_





CONTACT: \_\_\_\_\_

DATE: \_\_\_\_\_

NOTES: \_\_\_\_\_

APPROVAL: \_\_\_\_\_

*In keeping with our policy of continuing product improvement, Elkay reserves the right to change product specifications without notice. Please visit [elkay.com](#) for the most current version of Elkay product specification sheets. This specification describes an Elkay product with design, quality, and functional benefits to the user. When making a comparison of other producers' offerings, be certain these features are not overlooked.*

Included Accessories		
<a href="#">LKF413945RS</a>	Everyday Kitchen Faucet with Remote Lever Handle Restricted Spout Chrome <a href="#">Spec Sheet (PDF)</a>	
<a href="#">LK1141A</a>	Elkay Flexi-Guard® Safety Bubbler Classroom Bubbler <a href="#">Spec Sheet (PDF)</a>	
<a href="#">LKAD35</a>	3-1/2" Drain Fitting" Stainless Steel Body Strainer Basket and Offset Tailpiece <a href="#">Spec Sheet (PDF)</a>	
<a href="#">EF3000VRBMC</a>	Elkay Universal Vandal-Resistant 3000 Gal. Filtration Kit with Filter Status Monitor <a href="#">Spec Sheet (PDF)</a>	

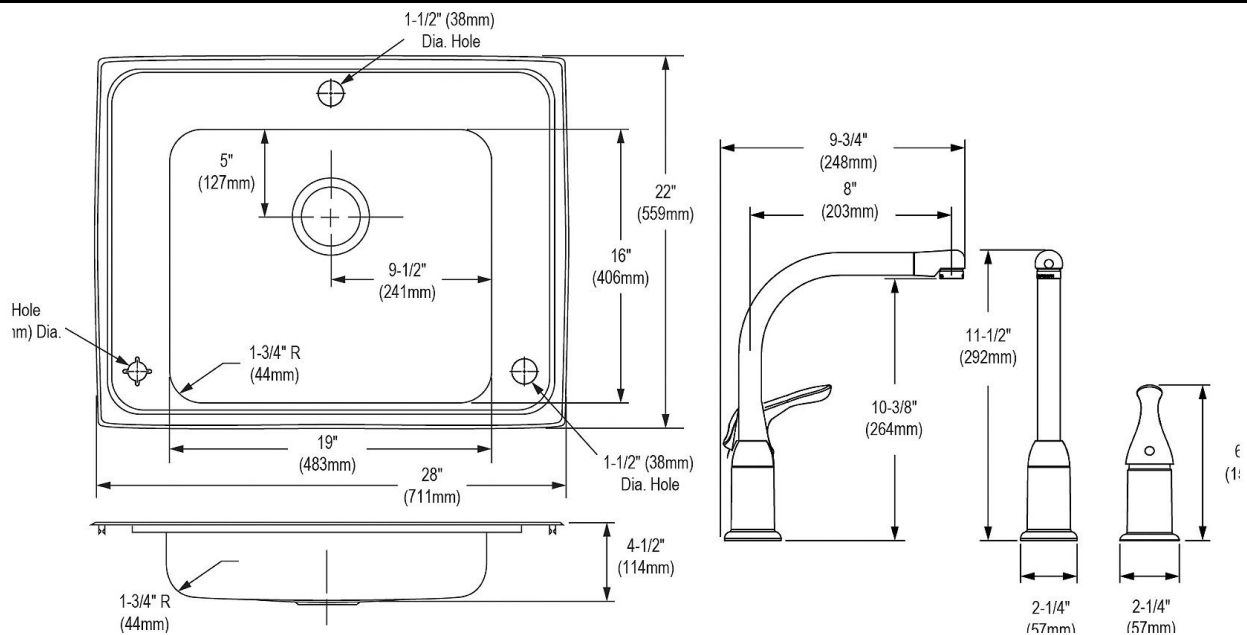

In keeping with our policy of continuing product improvement, Elkay reserves the right to change product specifications without notice. Please visit [elkay.com](http://elkay.com) for the most current version of Elkay product specification sheets. This specification describes an Elkay product with design, quality, and functional benefits to the user. When making a comparison of other producers' offerings, be certain these features are not overlooked.

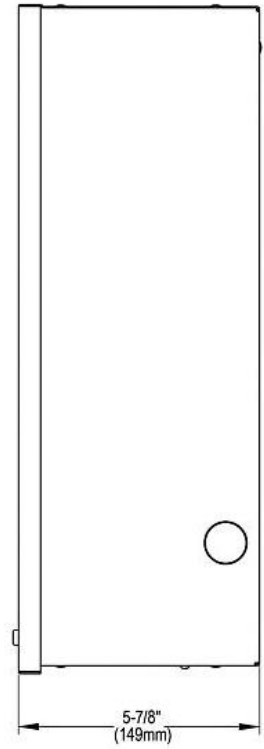
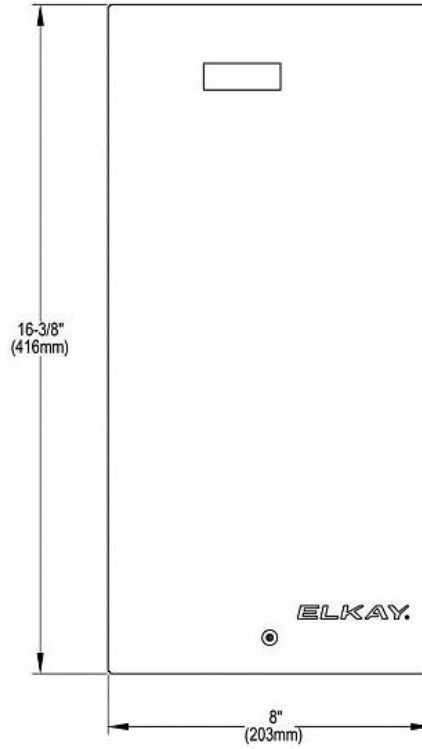

*In keeping with our policy of continuing product improvement, Elkay reserves the right to change product specifications without notice. Please visit [elkay.com](http://elkay.com) for the most current version of Elkay product specification sheets. This specification describes an Elkay product with design, quality, and functional benefits to the user. When making a comparison of other producers' offerings, be certain these features are not overlooked.*