

**PRODUCT SPECIFICATIONS**

Lustertone® Stainless Steel Single Bowl Top Mount Sink. Overall dimensions are 25" x 22" x 6-1/2". Sink is manufactured from 18 gauge 304 Stainless Steel with a Lustrous Highlighted Satin finish, Rear Center drain placement and Full spray sides and bottom.

<b>Installation Type:</b>	Top Mount
<b>Material:</b>	304 Stainless Steel
<b>Finish:</b>	Lustrous Highlighted Satin
<b>Gauge:</b>	18
<b>Sound Deadening:</b>	Full spray sides and bottom
<b>Number of Bowls:</b>	1
<b>Sink Dimensions:</b>	25" x 22" x 6-1/2"
<b>Bowl 1 Dimensions:</b>	16" x 19" x 6-3/8"
<b>Drain Size:</b>	3-1/2" (89mm)
<b>Drain Location:</b>	Rear Center
<b>Minimum Cabinet Size:</b>	30"
<b>Mounting Hardware:</b>	Part # 64090012 included for countertops up to 3/4" (19mm) thick
<b>Cutout Template #:</b>	<a href="#">1000001188</a>

Template is available for download at [elkay.com](#)

**Cutout Dimensions for Top Mount Installation:**

24-3/8" x 21-3/8" (619mm x 543mm) with 1-1/2" (38mm) corner radius



This sink is compliant to ADA and ANSI/ICC A117.1 accessibility requirements when installed according to the requirements outlined in these standards.

**Hole Drilling Configurations:**

1-1/2" (38mm) Diameter Faucet Holes on 4" (102mm) Centers  
1-1/8" (29mm) Diameter Slotted Hole

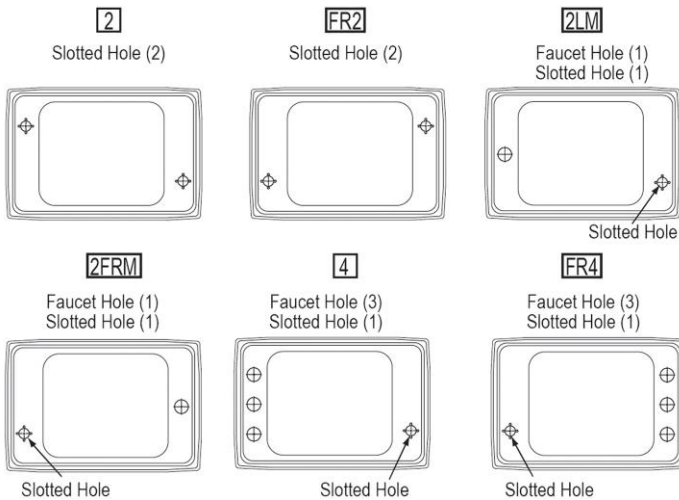

AMERICAN PRIDE. A LIFETIME TRADITION. Like your family, the Elkay family has values and traditions that endure. For almost a century, Elkay has been a family-owned and operated company, providing thousands of jobs that support our families and communities.



Sinks are listed by IAPMO® as meeting the applicable requirements of the Uniform Plumbing Code®, International Plumbing Code®, and National Plumbing Code of Canada.

**Product Compliance:** ADA  
BUY AMERICAN ACT  
ASME A112.19.3/CSA B45.4

[Clean and Care Manual \(PDF\)](#)  
[Installation Instructions \(PDF\)](#)  
[Limited Lifetime Warranty \(PDF\)](#)

**Similar models are available with:** Quick-Clip Mounting System, additional ADA depths

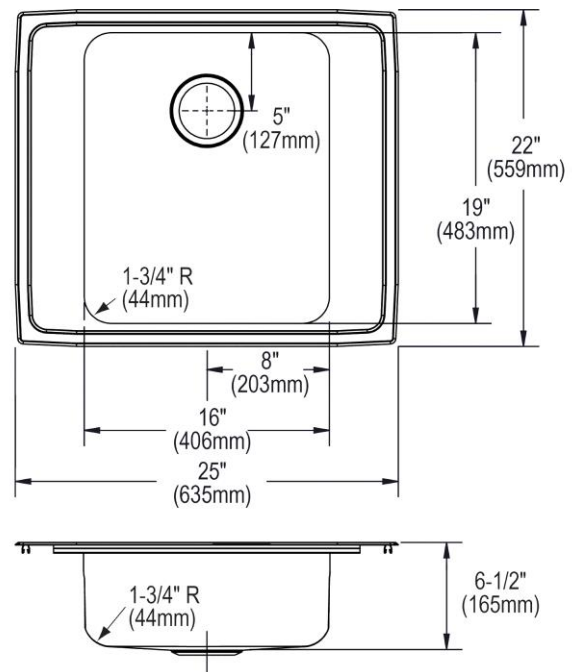

PART: \_\_\_\_\_ QTY: \_\_\_\_\_  
PROJECT: \_\_\_\_\_  
CONTACT: \_\_\_\_\_  
DATE: \_\_\_\_\_  
NOTES: \_\_\_\_\_  
APPROVAL: \_\_\_\_\_

In keeping with our policy of continuing product improvement, Elkay reserves the right to change product specifications without notice. Please visit [elkay.com](#) for the most current version of Elkay product specification sheets. This specification describes an Elkay product with design, quality, and functional benefits to the user. When making a comparison of other producers' offerings, be certain these features are not overlooked.

**Installation Profile:**

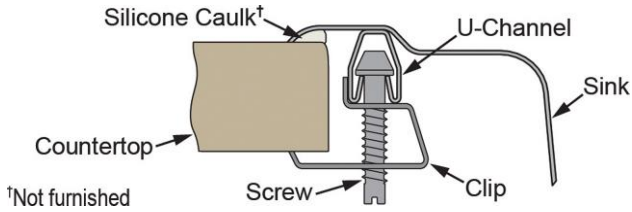

**OPTIONAL ACCESSORIES**

<b>Hardware:</b>	LK364, LK463
<b>Sinkmate:</b>	LKSM17, LKSMHOOK, LKSMSPONGE, LKSMHSL

*In keeping with our policy of continuing product improvement, Elkay reserves the right to change product specifications without notice. Please visit [elkay.com](http://elkay.com) for the most current version of Elkay product specification sheets. This specification describes an Elkay product with design, quality, and functional benefits to the user. When making a comparison of other producers' offerings, be certain these features are not overlooked.*