

PRODUCT SPECIFICATIONS

Elkay Dart Canyon Stainless Steel 32-7/8" x 27-1/4" x 9-5/8", Single Bowl Farmhouse ADA Workstation Sink. Sink is manufactured from 16 gauge 304 Stainless Steel with a Polished Satin finish, Rear Center drain placement, and Full spray sides and bottom with Sides and Bottom pads.

Installation Type:	Farmhouse
Material:	304 Stainless Steel
Special Features:	Work Shelf, Workstation
Finish:	Polished Satin
Gauge:	16
Sound Deadening:	Full spray sides and bottom with Sides and Bottom pads
Number of Bowls:	1
Sink Dimensions:	32-7/8" x 27-1/4" x 9-5/8"
Bowl 1 Dimensions:	28-7/8" x 14-7/16" x 9-5/8"
Drain Size:	3-1/2" (89mm)
Drain Location:	Rear Center
Minimum Cabinet Size:	33"
Mounting Hardware:	Part # 54300308 included



Included with Product: ELDSSF33279 sink, CTXBG2813R bottom grid, CTXDC0606 bottom grid drain cover, LKDD deep strainer drain

AMERICAN PRIDE. A LIFETIME TRADITION.
Like your family, the Elkay family has values and traditions that endure. For almost a century, Elkay has been a family-owned and operated company, providing thousands of jobs that support our families and communities.

Product Compliance: ASME A112.19.3/CSA B45.4
Accessory: ASME A112.18.2/CSA B125.2

Installation Profile:

1/8" OVERHANG

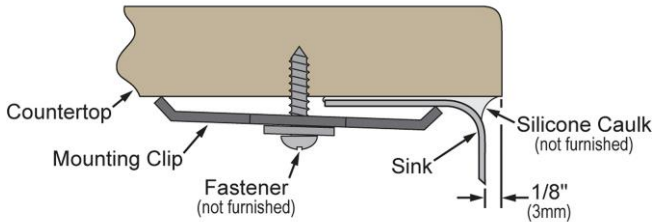

Designed to affix to the underside of any solid surface countertop.

OPTIONAL ACCESSORIES

Drain:	LKDD
Hardware:	LKUCLIP8 (2 Required)



Sinks are listed by IAPMO[®] as meeting the applicable requirements of the Uniform Plumbing Code[®], International Plumbing Code[®], and National Plumbing Code of Canada.

Complies with ADA & ICC A117.1 accessibility requirements when installed according to the requirements outlined in these standards.

[Clean and Care Manual \(PDF\)](#)
[Installation Instructions \(PDF\)](#)
[Warranty \(PDF\)](#)

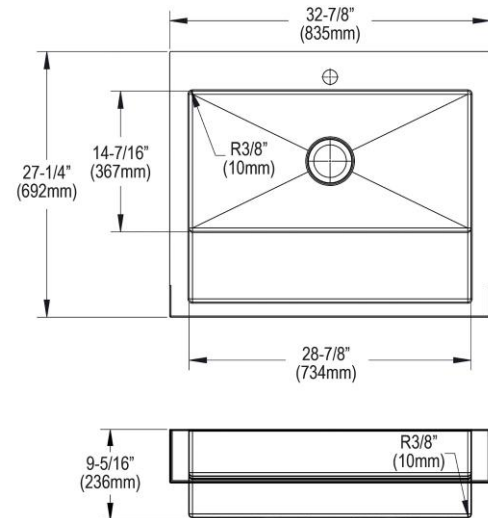

PART: _____ QTY: _____

PROJECT: _____

CONTACT: _____

DATE: _____

NOTES: _____

APPROVAL: _____

In keeping with our policy of continuing product improvement, Elkay reserves the right to change product specifications without notice. Please visit elkay.com for the most current version of Elkay product specification sheets. This specification describes an Elkay product with design, quality, and functional benefits to the user. When making a comparison of other producers' offerings, be certain these features are not overlooked.