

2538-DST, 2551-DST, 2552-DST, 2555-DST, 2564-DST, 2592-DST & 2594-DST

RP41588▲

Lift Rod
Barra de Alzar
Tige de Manoeuvre

RP60352

Bonnet Nuts
Bonetes/Capuchones
Chapeaux Filetés

RP60400

Valve Assembly
Ensamble de la Válvula
Soupape

RP60400

Valve Assembly
Ensamble de
la Válvula
Soupape

RP54977

Aerator & Wrench
Aereador y Llave
Aérateur et Clé

RP73814

Gasket
Empaque
Joint

RP53531

Locknuts
Contratuercas
Écrous de Blocage

RP48428

Aerator & Wrench
Aereador y Llave
Aérateur et Clé
(Tesla™ 2552-DST only)

RP51243

Gaskets (2)
Empaques (2)
Joints (2)

▲Specify Finish
Especifique el Acabado
Précisez le Fini

2538-DST



H238▲

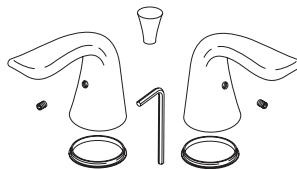

2555-DST



H216▲

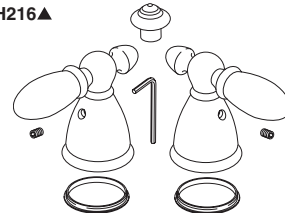

2551-DST

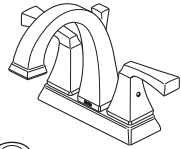

H251▲

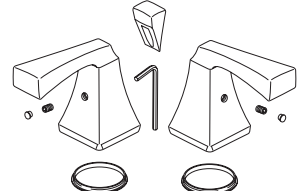

2592-DST



H292▲

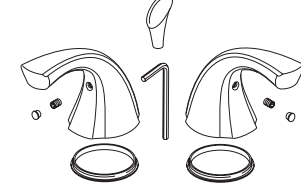

2552-DST

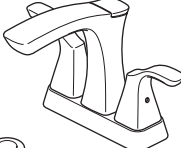

H252▲

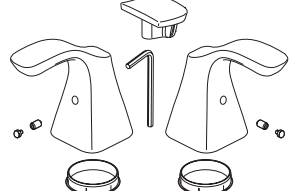

2594-DST



H294▲



RP72130▲

Decorative Supply Line Covers (metal)
Quantity 2, 30" Long
Available as Accessory Order (Not Included)
Tapas Decorativas para las Líneas de Suministro (metal)
Cantidad 2, 30" de largo
Disponible como orden accesorio (No incluido)
Tubes décoratifs sur le tuyau d'arrivée d'eau (métal)
Quantité 2, 30 po de longueur
Livrablé séparément seulement (non inclus)

RP72131▲

Decorative Supply Line Covers (PVC)
Quantity 2, 30" Long
Available as Accessory Order (Not Included)
Tapas Decorativas para las Líneas de Suministro (PVC)
Cantidad 2, 30" de largo
Disponible como orden de accesorio (No incluido)
Tubes décoratifs sur le tuyau d'arrivée d'eau (PVC)
Quantité 2, 30 po de longueur
Livrablé séparément seulement (non inclus)

2564-DST



H264▲

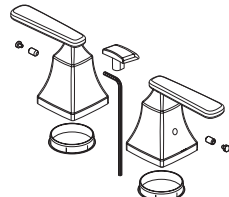

RP26533▲

Metal Pop-Up Assembly Less Lift Rod
 Ensemble de Metal del Desagüe Automático Sin la Barra de Alzar
 Renvoi Mécanique en Métal Sans la Tige de Manoeuvre

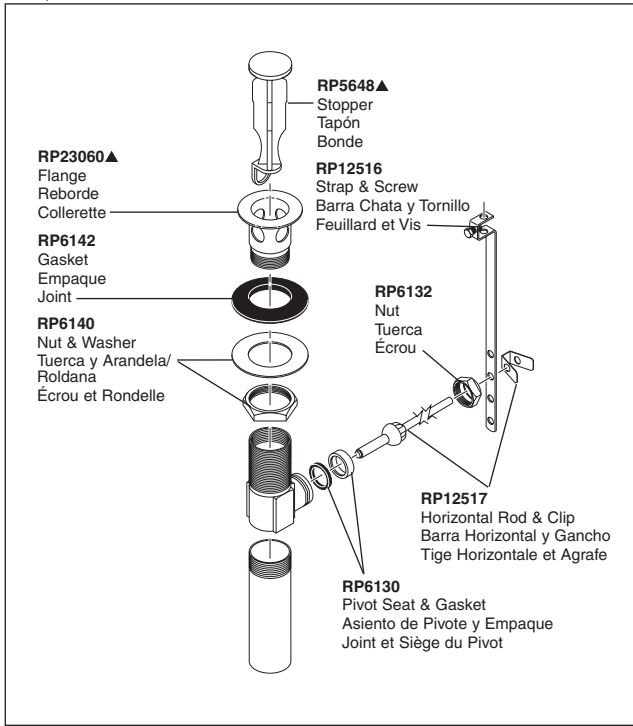
**RP34953**

Plastic Pop-Up Assembly
 Ensemble del Desagüe Automático Plástico
 Renvoi Mécanique en Plastique

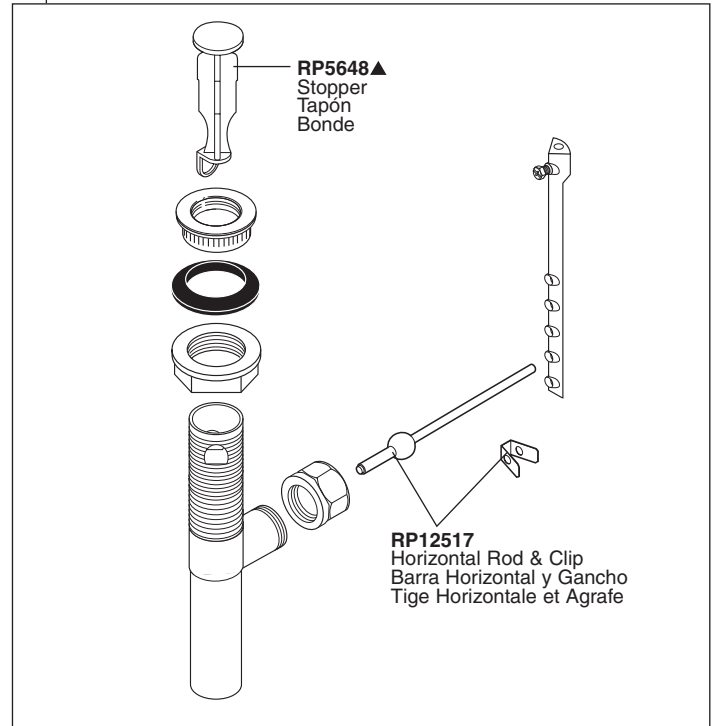
**RP38958▲**

Pop-Up with Metal Flange and Plastic Tail Piece Less Lift Rod
 Drenaje automático con brida de metal y la pieza de cola plástica menos la barra de alzar
 Renvoi mécanique avec collettere en métal et raccord droit de vidange en plastique sans la tige de manoeuvre

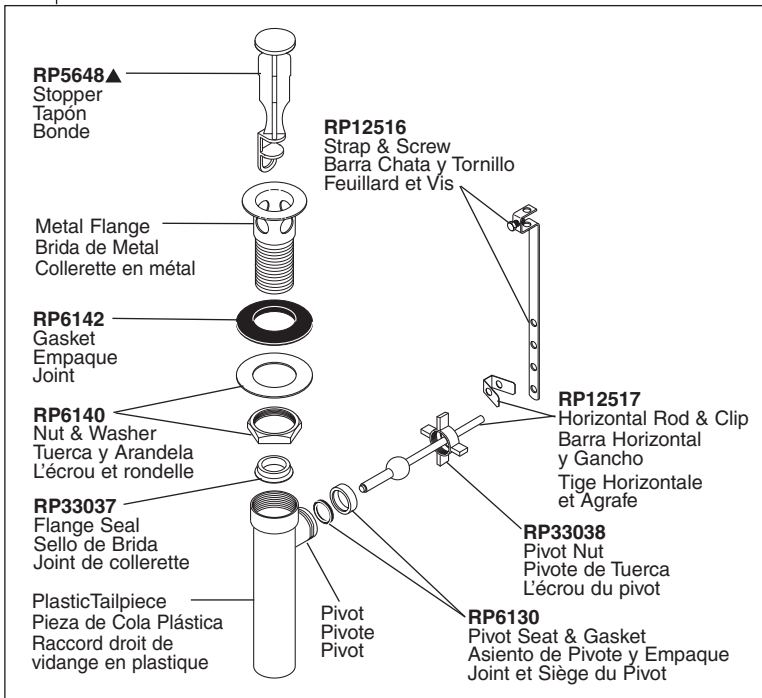

RP50952
 Plastic Sleeves
 Mangas Plásticas
 Manchons en plastique

RP63263
 Adapters
 3/8"-24 UNEF to 1/2"-20 UN &
 3/8"-24 UNEF to 1/2"-14 NPSM
 Adaptadors
 3/8"-24 UNEF to 1/2"-20 UN &
 3/8"-24 UNEF to 1/2"-14 NPSM
 Adapteurs
 3/8 po-24 UNEF to 1/2 po-20 UN et
 3/8 po-24 UNEF to 1/2 po-14 NPSM

▲ Specify Finish
 Especifico el Acabado
 Précisez le Fini