

MODEL NUMBER:

- ❑ **R422 Two-Way In-Wall Diverter Valve Rough (Discrete)**
1/2" NPT inlets/outlets. 2 Discrete functions. LESS Handle.
- ❑ **R422S Two-Way In-Wall Diverter Valve Rough (Shared)**
1/2" NPT inlets/outlets. 2 Discrete/1 Shared functions. LESS Handle.

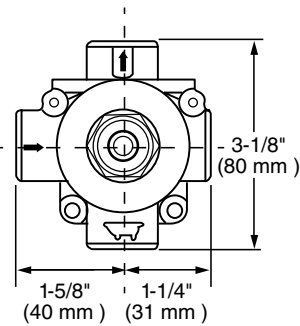

ALL CONNECTIONS 1/2" NPT

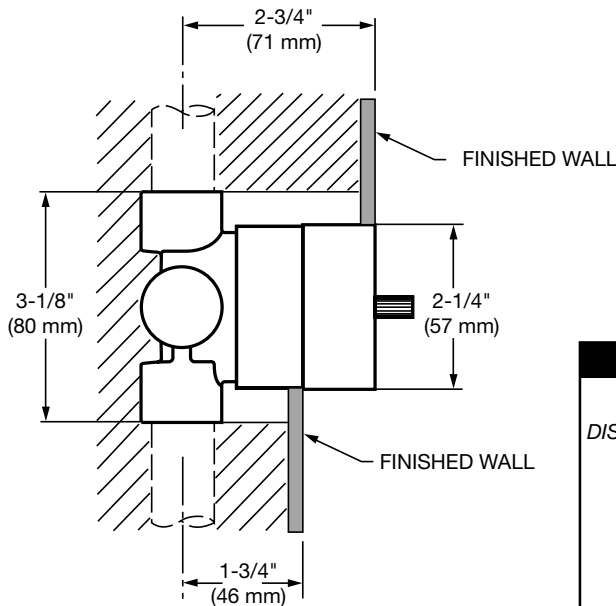
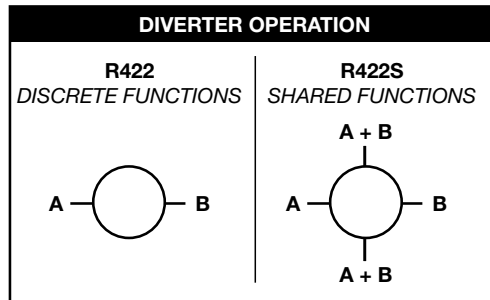

GENERAL DESCRIPTION:

In-Wall Diverter: Rotational control alternates water flow between two different shower outlets (i.e. showerhead, handspray, body side spray or tub spout). Forged brass valve body. Mixed water inlet and two outlets are marked on back of valve body. 1/2" NPT connections on mixed water inlet and two outlets. Stamped brass escutcheon. Tub port with increased water flow (see chart).

NOTE: Cannot be used as a shut-off valve.

PRODUCT FEATURES:

- Solid Brass Construction:** Durable, ideal material for prolonged contact with water.
- Removable Plaster Guard:** Permits checking of valve installation prior to installing trim parts.

SUGGESTED SPECIFICATION

Two way diverter shall feature a forged brass body with 1/2" NPT mixed water inlet and outlets. Fitting shall be American Standard Model # R422_.

CODES AND STANDARDS

These products meet or exceed the following codes and standards:

ASME A112.18.1
CSA B125.1



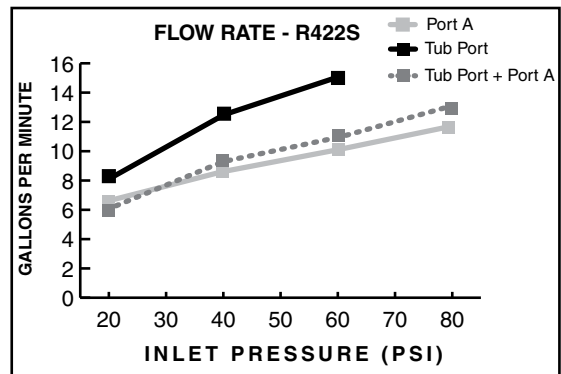
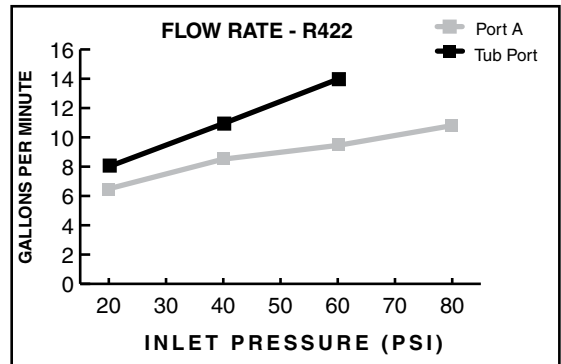











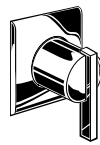
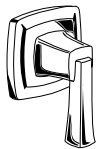



 Meets the American Disabilities Act Guidelines and **ANSI A117.1** Requirements for the physically challenged.



ROUGH VALVE BODIES	Product Number	Description
	R422*	Two-Way In-Wall Diverter. 2 Discrete functions. LESS handle.
	R422S*	Two-Way In-Wall Diverter. 2 Discrete/1 Shared functions. LESS handle.

*Rough and Trim must be ordered separately.

R422 and R422S will accept the following handles:

AVAILABLE TRIM KITS	Town Square®	Serin®	Green Tea®	Moments®	Times Square®	Townsend®
						
	T555.430 	T064.430 	T010.430 	T506.430 	T184.430 	T353.430 
	Berwick®	Berwick®	Portsmouth®	Portsmouth®	Quentin®	
						
T430.430 	T430.432	T420.430 	T420.432	T440.430 